

*TB 9-6625-2296-35

DEPARTMENT OF THE ARMY TECHNICAL BULLETIN

CALIBRATION PROCEDURE FOR RADIO TEST SET AN/GRM-114B, AN/GRM-122 AND TS-4317/GRM

Headquarters, Department of the Army, Washington, DC
21 June 2006

Distribution Statement A: Approved for public release, distribution is unlimited.

REPORTING OF ERRORS AND RECOMMENDING IMPROVEMENTS

You can improve this manual. If you find any mistakes or if you know of a way to improve these procedures, please let us know. Mail your letter or DA Form 2028 (Recommended Changes to Publications and Blank Forms) directly to Commander, US Army Aviation and Missile Command, ATTN: AMSAM-MMC-MA-NP, Redstone Arsenal, AL 35898-5000. A reply will be furnished to you. You may also provide DA Form 2028 information to AMCOM via e-mail, fax, or the World Wide Web. Our FAX number is: DSN 788-6546 or Commercial 256-842-6546. Our e-mail address is: 2028@redstone.army.mil. Instructions for sending an electronic 2028 may be found at the back of this manual. For the World Wide Web, use: <https://amcom2028.redstone.army.mil>.

SECTION		Paragraph	Page
I.	IDENTIFICATION AND DESCRIPTION		
	Test instrument identification.....	1	2
	Forms, records, and reports.....	2	2
	Calibration description	3	2
II.	EQUIPMENT REQUIREMENTS		
	Equipment required	4	5
	Accessories required.....	5	6
III.	CALIBRATION PROCESS		
	Preliminary instructions.....	6	8
	Equipment setup	7	8
	AF generator frequency	8	10
	AF generator output level.....	9	12
	Distortion meter	10	17
	SINAD meter	11	18
	Digital multimeter.....	12	20
	Generator output level.....	13	22
	Generator spectral purity	14	25
	Generator residuals.....	15	27
	Generator frequency.....	16	28
	Oscilloscope.....	17	30
	Spectrum analyzer.....	18	33
	Power meter calibration.....	19	42
	Generator amplitude modulation.....	20	47

*This bulletin supersedes TB 9-6625-2296-35, dated 20 January 1998, including all changes.

	Paragraph	Page
Generator frequency modulation.....	21	51
FM deviation meter (peak)	22	56
Amplitude modulation meter.....	23	62
Frequency error meter and RF counter	24	64
AF counter.....	25	66
Power supply.....	26	67
J-4843A/GRM and PL-1536/GRM Self Test (AN/GRM-122 only)	27	68
J-4843/GRM Self Test (AN/GRM-114B only)	28	69
Final procedure.....	29	72

**SECTION I
IDENTIFICATION AND DESCRIPTION**

1. Test Instrument Identification. This bulletin provides instructions for the calibration of Radio Test Set, AN/GRM-114B, AN/GRM-122 and TS-4317/GRM. The manufacturers’ manuals, TM 11-6625-3245-40, and TM 11-6625-3244-40 were used as the prime data sources in compiling these instructions. The equipment being calibrated will be referred to as the TI (test instrument) throughout this bulletin.

a. Model Variations. None.

b. Time and Technique. The time required for this calibration is approximately 16 hours, using the dc and low frequency and microwave technique.

2. Forms, Records, and Reports

a. Forms, records, and reports required for calibration personnel at all levels are prescribed by TB 750-25.

b. Adjustments to be reported are designated (R) at the end of the sentence in which they appear. When adjustments are in tables, the (R) follows the designated adjustment. Report only those adjustments made and designated with (R).

3. Calibration Description. TI parameters and performance specifications which pertain to this calibration are listed in table 1.

Table 1. Calibration Description

Test instrument parameters	Performance specifications
RF SIGNAL GENERATOR	
Frequency Range	500.0 kHz to 999.9999 MHz
Accuracy	±0.5 PPM
Output Level Range	-122 to 0 dBm
Accuracy	±2.0 dB @ 0 to ≤ -90 dBm ¹ ±2.5 dB @ -122 to -90 dBm ±3.5 dB >400 MHz

See footnote at end of table.

Table 1. Calibration Description

Test instrument parameters	Performance specifications
RF SIGNAL GENERATOR - CONTINUED	
Phase Noise	<-90 dBc/Hz at 20 kHz from output frequency >1 MHz to <930 MHz <-85 dBc/Hz at 20 kHz from output frequency ≥930 MHz <-80 dBc/Hz at 20 kHz from output frequency 500 kHz to ≤1 MHz
Harmonics	<-26 dBc
Non-Harmonics	<-50 dBc
Residual AM	(Post detection BW: 50 Hz to 15 kHz) < 0.10% RMS from 1 to 999.9999 MHz < 0.20% RMS ≤ 1 MHz
FM Deviation Range Modulation Rates Accuracy Total Harmonic Distortion (sine wave only):	±100 Hz to ±25.0 kHz 30 Hz to 20 kHz ±5% at 1.0 thru 20.0 kHz ±10% at 100 Hz to <1.0 kHz and >20.0 kHz to 25.0 kHz >6 kHz deviation (sine wave only) <0.7% (700 Hz thru 1.1 kHz); 0.3 to 3 kHz post detection filter <1.0% (30 Hz thru 10 kHz) <2.0% (> 10.0 thru 20.0 kHz)
AM Deviation Range Modulation Rates Accuracy Total Harmonic Distortion (30% to 70%) (sine wave only)	750 kHz to 999.9999 MHz (1 to 90%) 100 Hz to 10 kHz ±5% of setting (30% thru 90% mod) ±10% of setting (30% thru 90% mod) $f_c \leq 1$ MHz <0.7 % (700 Hz thru 1.1 kHz); 0.3 to 3 kHz post detection filter <1.5% (100 Hz thru 6.0 kHz) <2.5% (> 6 thru 10.0 kHz) <5.0% (0.75 thru 1.0 MHz)
POWER METER	
Frequency Range Level Range Accuracy	1.5 to 999.9999 MHz 0.2 mW to 200 W (up to 30 MHz) 0.2 mW to 100 W (>30 to 200 MHz) 0.2 mW to 50 W (>200 to 999.9999 MHz) 10% (up to 400 MHz) ±1 count 20% (beyond 400 MHz) ±1 count

Table 1. Calibration Description - Continued

Test instrument parameter	Performance specifications
RADIO FREQUENCY METER	
Frequency Range	250 kHz to 999.9999 MHz
Level Range	-10 to 50 dBm (250 kHz to <200 MHz)
Accuracy	-10 to 47 dBm (200 to 999.9999 MHz) ±0.5 PPM
RADIO FREQUENCY ERROR METER	
Counter Range	0 to ±150 kHz
Meter Range	0 to ±100 kHz
Level Range	-10 to +50 dBm at T/R connector
Accuracy	±0.5 ppm
AUDIO FREQUENCY METER	
Range	10.0 Hz to 40.0 kHz
Accuracy	±0.5 ppm
FM DEVIATION METER	
Range	0 Hz to ±100 kHz (+ peak and - peak)
Modulation Rate	100 Hz to <20 kHz (300 kHz IF) 100 Hz to <3 kHz (30 kHz IF)
Accuracy	±4.0% ±2 counts (300 kHz IF, <15 kHz rate) (FM zeroed) ±7.0% ±2 counts (300 kHz IF, ≥15 kHz rate) (FM zeroed) ±7.0 %, ±2 counts, (30 kHz IF) (FM zeroed)
AM MODULATION METER	
Range	30% to 90%
Modulation Rate	100.0 Hz to 10.0 kHz
Accuracy	5% full scale, ±1 count from 30% thru 90%
DISTORTION METER	
Range	1% to 20.0%
Accuracy	±0.5% distortion, ±1 count, from 1% thru ≤10% ±2.0% distortion, ±1 count, from > 10.0% thru 20.0%
Frequency	700 Hz and 1 kHz
SINAD METER	
Signal Frequency	770 Hz and 1.0 kHz
Signal Level	0.1 thru 30 V rms
Range	3.0 thru 30.0 dB
Accuracy	±1.0 dB, ±1 count
AF GENERATOR NO. 1 AND NO. 2	
Frequency Range	10.0 Hz to 40.0 kHz
Accuracy	±0.1%
Level range	0.7 mV rms to 2.5 V rms (150 Ω) up to 3.0 V rms (600 Ω) (150 Ω load) ±0.1 mV or <3% (≤10 kHz)
Accuracy	<5.0% (>10 to 25 kHz)
Spectral Purity THD (sine wave only)	<1.0% <0.7% (0.7 to 1.1 kHz)

Table 1. Calibration Description - Continued

Test instrument parameter	Performance specifications
OSCILLOSCOPE	
Vertical Input Frequency Range Range Accuracy	DC to 1.0 MHz (at 3 dB bandwidth) 2.0 mV to 50 V per division with 8 divisions on screen ±5% of full scale (±10% with 10X probe) ±10% of full scale in 2 mV range (±10% with 10X probe)
Horizontal Sweep Range Accuracy	10 µs/div to 10 ms/div with 10 divisions on screen ±3% of full scale
SPECTRUM ANALYZER	
Frequency Range	1 to 999.9999 MHz
Frequency Span Range Accuracy	1.0 kHz/div to 1 MHz/div ±(5.0% of span width +0.5 ppm)
Level Range Dynamic Range Attenuator Overall Accuracy	10 dB/div -85 to -30 dB (at 0 dB attenuation) 0, 20, 40 dB ±4 dB (to 400.0 MHz normalized) ±5 dB (>400.0 to 999.9999 MHz normalized)
Bandwidth Switching Error:	<2 dB (3, 30 and 300 kHz RBW filters) <3 dB (0.3 kHz and 3 MHz RBW filters)
DIGITAL MULTIMETER	
VOLTMETER (AC/DC)²	
Range Accuracy	0.1 mV to 2000.0 V full scale ±5% full scale, ±1 count (ac) (50 Hz to 20 kHz) ±1% full scale, ±1 count (dc)
CURRENT METER	
Range Accuracy	0.01 mA to 10.0 A ±5% full scale or 0.1 mA, ±1 count
OHMMETER	
Range Accuracy	0.1 Ω to 20.0 MΩ ±5% full scale or 0.1 Ω, ±1 count

¹Not checked below 110 dB.

²Ac accuracy applies for ac volts times kHz product <140.

SECTION II EQUIPMENT REQUIREMENTS

4. Equipment Required. Table 2 identifies the specific equipment to be used in this calibration procedure. This equipment is issued with Secondary Transfer Calibration Standards Set AN/GSM-287. Alternate items may be used by the calibrating activity. The items selected must be verified to perform satisfactorily prior to use and must bear evidence of current calibration. The equipment must meet or exceed the minimum use specifications listed in table 2. The accuracies listed in table 2 provided a four-to-one ratio between the standard and TI. Where the four-to-one ratio cannot be met, the actual accuracy of the equipment is shown in parenthesis.

5. **Accessories Required.** The accessories listed in table 3 are issued as indicated in paragraph 4 above and are used in this calibration procedure. When necessary, these items may be substituted by equivalent items, unless specifically prohibited.

Table 2. Minimum Specifications of Equipment Required

Common name	Minimum use specifications	Manufacturer and model (part number)
AUDIO ANALYZER	Distortion capability: ≤ 10 dB distortion $\pm 0.5\%$ to 5.0% 10 Hz to 40 kHz Audio source: 2 V p-p 50Ω 600 to 2800 Hz Accuracy: $\pm 3\%$	Boonton, Model 1121 (1121)
CALIBRATOR	Ac volts: Range: 180 mV to 470 V 100 Hz to 20 kHz Accuracy: $\pm 1.28\%$ Dc volts: Range: 190 mV to 980 V Accuracy: $\pm 0.276\%$ Dc current: Range: 18 mA to 1.8 A Accuracy: $\pm 1.4\%$ Resistance: Range: 80Ω to $18 M\Omega$ Accuracy: $\pm 1.4\%$	Fluke, Model 5720A (5700A/EP) (p/o MIS-35947); w/amplifier, Fluke, Model 5725A/AR (5725A/AR)
MULTIMETER	Ac volts: Range: 20 Hz to 25 kHz 1 mV to 2.5 V rms Accuracy: ± 25 mV or $.75\%$ < 10 kHz $\pm 1.25\%$ > 10 to 25 kHz Dc volts: Range: 4.096 to 35 V dc Accuracy: $\pm (.0006\%) .005\%$	Hewlett-Packard, Model 3458A (3458A)
FREQUENCY COUNTER	Frequency range: 10 Hz to 999.9999 MHz Accuracy: ± 0.125 ppm	Fluke, Model PM 6681/656 (PM 6681/656)
FUNCTION/ARBITRARY GENERATOR	Frequency range: 1 kHz to 40 kHz Accuracy: $\pm 5\%$ Attenuators: $\pm 0.25\%$ -7 to +13.01 dB and 1 V p-p	Agilent, Model 33250A (33250A)

Table 2. Minimum Specifications of Equipment Required - Continued

Common name	Minimum use specifications	Manufacturer and model (part number)
MEASURING RECEIVER	Power measurement: Flatness: 500 kHz to 999 MHz Power: 0 to +30 dB ± 0.103 dB 0 to -110 ± 0.375 dB -110 to -127 ± 0.625 dB Accuracy: ± 0.5 dB FM: Range: 10 to 90 kHz Accuracy: $\pm 1\%$ <15 kHz mod rate ± 1.75 >15 kHz mod rate AM: Range: 0.1% 90% Accuracy: ± 1.25	Hewlett-Packard, Model 8902A (8902A) w/sensors, Hewlett-Packard, Model 11722A (11722A)
OSCILLOSCOPE	Range: 50 Hz Accuracy: <125 ns risetime	(OS-303/G)
OSCILLOSCOPE CALIBRATOR	Voltage: Range: 4 mV to 100 V dc Accuracy: $\pm 2.0\%$ Leveled sine wave: Frequency: 50 kHz and 1 MHz Markers: Range: 2 μ s to 100 ms/div Accuracy: $\pm 0.25\%$	Fluke Model 5820A-5C-GHz (5820A-5C-GHz)
POWER SPLITTER	Insertion loss -6dB Output tracking between ports: 10 MHz to 1 GHz: ± 0.15 dB	Weinschel, Model 1870A (7916839)
RESISTANCE STANDARD	Range: 150 Ω Accuracy: $\pm 1\%$	Biddle-Gray, Model 71-631 (7910328)
RF POWER METER	Frequency: 450 kHz to 1000 MHz Output: 7.5 to 85 W Accuracy: ($\pm 3\%$)	Bird, Model 4421 (4421) w/ Directional power sensors, Model 4021 and 4022 (4021 and 4022)
SPECTRUM ANALYZER	Frequency: 1 to 999.999 MHz Noise Floor: <50 dB	(AN/USM-677)
SIGNAL GENERATOR	Frequency: 1 to 900.15 MHz Resolution: 1 Hz Accuracy: ± 1.125 ppm Output: 0 to -40 dB 2 to 5 μ V Mod Freq: 100 Hz to 19 kHz FM: 1 to 90 kHz AM: 30 to 90 %	(SG-1207/U)
SYNTHESIZER/LEVEL GENERATOR	Frequency range: 999980 to 1.000020 MHz Resolution: .1 Hz	Hewlett-Packard, Model 3335A OPT 001-K06 (MIS-35938)

Table 2. Minimum Specifications of Equipment Required - Continued

Common name	Minimum use specifications	Manufacturer and model (part number)
VARIABLE ATTENUATOR	Range: 0 to -90 dB Accuracy: ±1 dB	Weinschel, Model AF117A-69-34 (AF117A-69-34)

Table 3. Accessories Required

Common name	Description (part number)
CALIBRATION KEY	LOCK OUT KEY (7005-7840-500)
RF POWER AMPLIFIER	ARA, Model 757LC (MIS-45845)
SERIAL INTERFACE CABLE ASSEMBLY ¹	NULL MODEM CABLE
TEST FIXTURE ²	TF-119A (7001-1542-400)
TEST FIXTURE ¹	TF-119

¹For AN/GRM-114B only.

²For AN/GRM-122 only.

SECTION III CALIBRATION PROCESS

6. Preliminary Instructions

a. The instructions outlined in paragraphs 6 and 7 are preparatory to the calibration process. Personnel should become familiar with the entire bulletin before beginning the calibration.

b. Items of equipment used in this procedure are referenced within the text by common name as listed in table 2.

c. Unless otherwise specified, verify the result of each test, and whenever the test requirement is not met take corrective action before continuing with the calibration. Adjustments required to calibrate the TI are included in the procedure. Additional maintenance information is contained in TM 11-6625-3244-40 and TM 11-6625-3245-40 for these TIs.

d. When indications specified in paragraphs 8 through 25 are not within tolerance, perform the power supply check prior to making adjustments. After adjustments are made, repeat paragraphs 8 through 25. Do not perform power supply check if all other parameters are within tolerance.

e. Unless otherwise specified, all controls and control setting refer to the TI.

7. Equipment Setup

WARNING

HIGH VOLTAGE is used or exposed during the performance of this calibration. DEATH ON CONTACT may result if personnel fail to observe safety precautions. REDUCE OUTPUT(S) to minimum after each setup within the performance check where applicable.

a. Connect TI to a 115 V ac source.

- b. Press **POWER** key **ON** and allow 1 hour for equipment warm-up.

NOTE

Before starting calibration make sure TI has the latest software. In the upper right portion of the screen the software version will be listed (Ex. TS-4317 V. X.XX, PL-1536/GRM V. X.XX). To find out the latest software version go to the USATA website and look under the following headers: Calibration Support>CALSETS 2000>CAL 2000 Program>Integrated Calibration Environment (ICE) Product Team>AN/GRM-122 Software Updates. Update software if applicable.

- c. Connect calibration key to **MIC/ACC IN/OUT**.

NOTE

If no auxiliary box is connected to TI rear panel **SCSI**, TI SCSI must be disabled in **d** below prior to performing self test in **e** below. Do not perform **d** below if Auxiliary Box is connected to TI rear panel **SCSI**.

- d. Press key sequence listed in (1) through (5) below:

- (1) **MODE MTRS**..... Meters Menu
- (2) **AUX (F6)**..... Auxiliary Functions Menu
- (3) **DATA ENTRY 5**..... Configure submenu
- (4) **DATA ENTRY 3**..... Configure SCSI
- (5) **DATA ENTRY ENTER**..... Operation Mode off

- e. Press key sequence listed in (1) through (14) below:

- (1) **MODE MTRS**..... Meters Menu
- (2) **AUX (F6)**..... Auxiliary Functions Menu
- (3) **DATA ENTRY 1**..... Calibration Menu
- (4) **Cal msg (F1)** Cal message Menu
- (5) **Enable Messaging** Toggle to off
- (6) **ESC (F6)** Cal message Menu
- (7) **AUX (F6)**..... Auxiliary Functions Menu
- (8) **MEMORY RCL**..... Recall Parameters Menu
- (9) **FIELD SELECT ↑**..... Highlight **10. Factory Defaults**
- (10) **DATA ENTRY ENTER**..... Factory Defaults recall

NOTE

Assure highlighted area indicates **YES** before proceeding.

- (11) **DATA ENTRY ENTER** Factory Defaults restored
- (12) **AUX (F5)**..... Auxiliary Functions Menu
- (13) **DATA ENTRY 4** Self Test
- (14) **DATA ENTRY ENTER**..... Test Running

NOTE

When self test is completed, ensure **P** is displayed next to **Self Test**; otherwise refer to TM for maintenance action.

f. Press key sequence listed in (1) through (4) below:

- (1) **MODE RCVR** Receiver screen
- (2) **More (F6)** Additional Selections
- (3) **DATA ENTRY 1 2 1 . 1 M**..... 121.1 MHz
- (4) Verify **RF IN** indicates **ANT**; if not, press **Ant (F3)** key.

g. Connect signal generator **RF OUTPUT** to **TI ANTENNA**.

h. Set signal generator for a 121.1 MHz, -30 dBm output.

i. Press key sequence listed in (1) through (6) below:

- (1) **MODE MTRS** Meter Menu
- (2) **AUX (F6)** Auxiliary Functions Menu
- (3) **DATA ENTRY 1**..... Calibrations
- (4) **DATA ENTRY 7**..... Signal Meter
- (5) **DATA ENTRY ENTER**..... Enter to Cal
- (6) **DATA ENTRY 1 0 0 ENTER**..... Correction Factor

j. Press **Ret (F5)** (Return), **MODE RCVR**, **DATA ENTRY SHIFT**, **DATA ENTRY Y** (Backup Cal Data ? y/n) keys.

k. Disconnect signal generator from TI.

8. AF Generator Frequency

a. Performance Check

(1) Press key sequence listed in (a) through (f) below:

- (a) **MODE MTRS** Meter Menu
- (b) **AUX (F6)** Auxiliary Functions Menu

- (c) **MEMORY RCL** Recall Parameters Menu
- (d) **FIELD SELECT** ↑ Highlight **10. Factory Defaults**
- (e) **DATA ENTRY ENTER** Factory Defaults recall

NOTE

Assure highlighted area indicates **YES** before proceeding.

- (f) **DATA ENTRY ENTER** Factory Defaults restored

(2) Connect TI **AUDIO OUT** to frequency counter **A** input and resistance standard set to 150 Ω.

(3) Press key sequence listed in (a) through (k) below:

- (a) **MODE AF GEN**..... AF GEN Screen
- (b) **SETUP** AF Gen Menu
- (c) **DATA ENTRY 5** AF Output Setup
- (d) **DATA ENTRY 4** Func Gen Out Level
- (e) **DATA ENTRY 2 ENTER** 2 V setting
- (f) **ESC (F6)** AF Gen Menu
- (g) **DATA ENTRY 1** AF Gen # 1 Setup
- (h) **DATA ENTRY 1** Func Gen 1 On
- (i) **DATA ENTRY 2** Freq
- (j) **DATA ENTRY 4 0 k** 40 kHz setting
- (k) **Ret (F5)**..... Return

(4) Frequency counter will indicate within limits specified in table 4 for TI AF Gen frequency 40 kHz setting.

(5) Press **FIELD SELECT** ↑ or ↓ key to select **GEN 1 AF**.

(6) Press **DATA ENTRY ENTER** key and repeat technique of (3) (j) above for each remaining TI AF Gen frequency setting listed in table 4. Frequency counter indications will be within limits specified in table 4.

Table 4. AF Generator Frequency/Distortion

Test instrument AF Gen frequency settings (Hz)	Frequency counter indications		Audio analyzer distortion indications
	Min	Max	
40 k	39.9600 kHz	40.040 kHz	<1.0%
20 k	19.980 kHz	20.020 kHz	<1.0%
10 k	9.990 kHz	10.010 kHz	<1.0%
1.1 k	1.0989 kHz	1.1011 kHz	<1.0%
1.0 k	999.0000 Hz	1.0010 kHz	<0.7%
700 ¹	699.3000 Hz	700.7000 Hz	<0.7%
10 ¹	9.9900 Hz	10.0100 Hz	<1.0%

¹Press **DATA ENTRY ENTER** key for Hz.

(7) Press key sequence listed in (a) through (g) below:

- (a) **FIELD SELECT** ↑ Select GEN 1
- (b) **DATA ENTRY ENTER** Set GEN 1 Off
- (c) **FIELD SELECT** ↓ Select GEN 2
- (d) **DATA ENTRY ENTER** Set GEN 2 On
- (e) **FIELD SELECT** ↓ Select GEN 2 AF
- (f) **DATA ENTRY ENTER** Highlight frequency setting
- (g) **DATA ENTRY 4 0 K** 40 kHz setting

(8) Repeat steps (4) and (6) above for **GEN 2 AF**.

(9) Press **FIELD SELECT** ↑ key to select **GEN 2** and press **DATA ENTRY ENTER** key to set **GEN 2 Off**.

(10) Connect TI **AUDIO OUT** to audio analyzer **INPUT HI** and resistance standard set to 150 Ω. Set audio analyzer to measure distortion in percent.

(11) Press key sequence listed in (a) through (e) below:

- (a) **FIELD SELECT** ↑ Select GEN 1
- (b) **DATA ENTRY ENTER** Set GEN 1 On
- (c) **FIELD SELECT** ↓ Select GEN 1 AF
- (d) **DATA ENTRY ENTER** Highlight frequency setting
- (e) **DATA ENTRY 4 0 K** 40 kHz setting

(12) Repeat technique of (4) and (6) through (9) above using audio analyzer distortion indications. Audio analyzer distortion indications will be within limits specified in table 4.

b. Adjustments. No further adjustments can be made.

9. AF Generator Output Level

a. Performance Check

(1) Press key sequence listed in (a) through (f) below:

- (a) **MODE MTRS** Meters Menu
- (b) **AUX (F6)** Auxiliary Functions Menu
- (c) **MEMORY RCL** Recall Parameters Menu
- (d) **FIELD SELECT** ↑ Highlight **10. Factory Defaults**
- (e) **DATA ENTRY ENTER** Factory Defaults recall

NOTE

Assure highlighted area indicates **YES** before proceeding.

- (f) **DATA ENTRY ENTER** Factory Defaults restored

(2) Connect TI **AUDIO OUT** to multimeter **INPUT HI** and **LO** and resistance standard set to 150 Ω. Set multimeter to measure volts ac.

(3) Press key sequence listed in (a) through (i) below:

- (a) **MODE AF GEN**..... AF GEN Screen
- (b) **FIELD SELECT ↑** Select GEN 1
- (c) **DATA ENTRY ENTER** Set GEN 1 On
- (d) **FIELD SELECT ↓** Select GEN 1 AF
- (e) **DATA ENTRY ENTER** Highlight frequency setting
- (f) **DATA ENTRY 2 0 ENTER..** 20 Hz setting

- (g) **FIELD SELECT ↓** Select LEVEL
- (h) **DATA ENTRY ENTER** Highlight level setting
- (i) **DATA ENTRY . 0 1 ENTER.** 10 mV setting

(4) If multimeter indication is not within limits specified in table 5 for TI 20 Hz, .010 V setting, perform **b** below.

(5) Repeat technique of (3) (h) and (3) (i) above for remaining TI **LEVEL** settings listed in table 5 for TI **AF** 20 Hz setting.

(6) Press **FIELD SELECT ↑** key to select **GEN 1 AF**.

(7) Repeat technique of (3) (e) through (6) for remaining TI settings listed in table 5. If multimeter indications are not within limits specified in table 5, perform **b** below.

Table 5. AF Generator Sine Wave Level Accuracy

Test instrument settings		Multimeter indications (V ac)	
LEVEL(V)	AF(Hz)	Min	Max
.010	20	.00970	.01030
.1	20	.0970	.1030
1	20	.970	1.030
2.5	20	2.425	2.575
2.5	1 k	2.425	2.575
1	1 k	.970	1.030
.1	1 k	.0970	.1030
.010	1 k	.00970	.01030
.010	11 k	.00950	.01050
.1	11 k	.095	.1050
1	11 k	.950	1.050
2.5	11 k	2.375	2.625
2.5	25 k	2.375	2.625
1	25 k	.950	1.050
.1	25 k	.095	.1050
.010	25 k	.00950	.01050

- (8) Press key sequence listed in (a) through (g) below:
- (a) **FIELD SELECT** ↑ Select GEN 1
 - (b) **DATA ENTRY ENTER** Set GEN 1 Off
 - (c) **FIELD SELECT** ↓ Select GEN 2
 - (d) **DATA ENTRY ENTER** Set GEN 1 On
 - (e) **FIELD SELECT** ↓ Select GEN 1 AF
 - (f) **DATA ENTRY ENTER** Highlight frequency setting
 - (g) **DATA ENTRY 2 0 ENTER..** 20 Hz setting

(9) Repeat technique of (4) through (7) above for **GEN 2**.

(10) Press **FIELD SELECT** ↑ key to select **GEN 2** and press **DATA ENTRY ENTER** key to set **GEN 2 Off**.

b. Adjustments

(1) Disconnect equipment from TI, press **TI POWER** key off, and remove function generator assembly A24 (fig. 1). Install function generator assembly using extender board (7010-7839-900). Press **TI POWER** key **ON**.

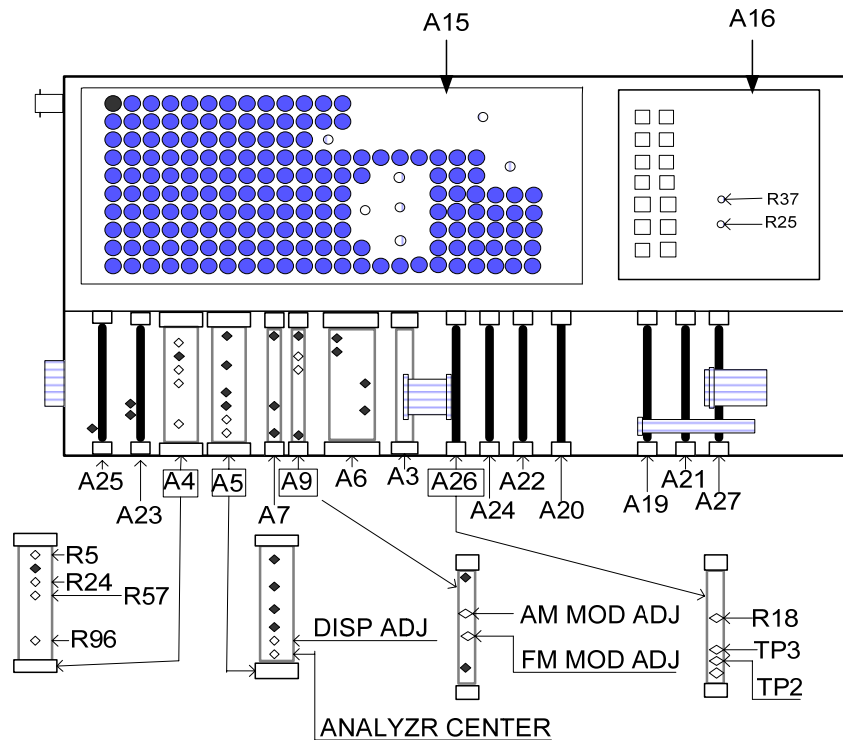

Figure 1. Top view.

- (2) Press key sequence listed in (a) through (f) below:
- (a) **MODE MTRS** Meters Menu
 - (b) **AUX (F6)** Auxiliary Functions Menu
 - (c) **MEMORY RCL** Recall Parameters Menu
 - (d) **FIELD SELECT ↑** Highlight **10. Factory Defaults**
 - (e) **DATA ENTRY ENTER** Factory Defaults recall

NOTE

Assure highlighted area indicates **YES** before proceeding.

- (f) **DATA ENTRY ENTER** Factory Defaults restored
- (3) Press key sequence listed in (a) through (m) below:
- (a) **MODE AF GEN**..... AF GEN screen
 - (b) **SETUP** AF Gen Menu
 - (c) **DATA ENTRY 1** AF Gen # 1 Setup
 - (d) **DATA ENTRY 3** Wave Form
 - (e) **DATA ENTRY 7** 0 Lvl
 - (f) **ESC (F6)** Escape
 - (g) **DATA ENTRY 2** AF Gen # 2 Setup
 - (h) **DATA ENTRY 3** Wave Form
 - (i) **DATA ENTRY 7** 0 Lvl
 - (j) **ESC (F6)** Escape
 - (k) **DATA ENTRY 5** AF Output Setup
 - (l) **DATA ENTRY 2** To Speaker On
 - (m) **Ret (F5)** Return

(4) Connect multimeter **INPUT HI** and **LO** to **TI AUDIO OUT**. Set multimeter to measure volts dc.

(5) Press **FIELD SELECT ↓** key to select **LEVEL** and press **DATA ENTRY ENTER** key. Press **DATA ENTRY 3 . 1** and **ENTER** keys.

(6) Press **FIELD SELECT ↑** key to select **GEN 1** and press **DATA ENTRY ENTER** key to set **GEN 1 On**.

(7) If multimeter does not indicate $0.000 \pm .01$ V dc adjust A24R23 (fig. 2) as close as possible.

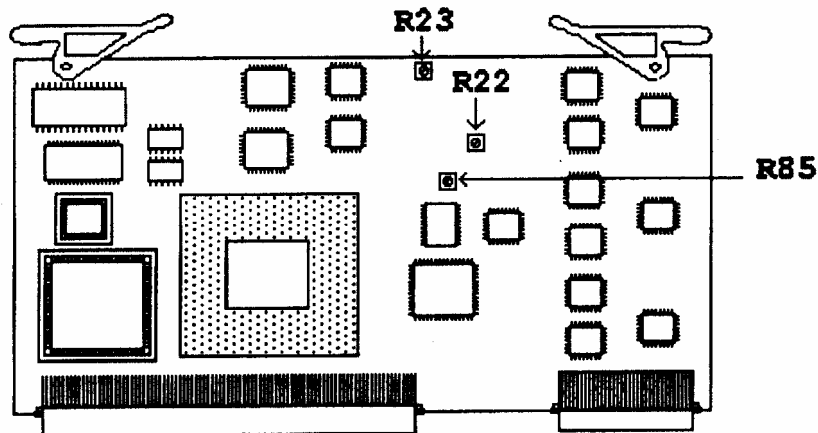

Figure 2. Function generator assembly A24.

(8) Press **DATA ENTRY ENTER** key to set **GEN 1 Off**. Press **FIELD SELECT ↓** key to select **GEN 2** and press **DATA ENTRY ENTER** key to set **GEN 2 On**.

(9) If multimeter does not indicate 0.000 ± 0.01 V dc adjust A24R22 (fig. 2) as close as possible.

(10) Press **DATA ENTRY ENTER** key to set **GEN 2 Off**. Press **FIELD SELECT ↑** key to select **GEN 1** and press **DATA ENTRY ENTER** key to set **GEN 1 On**.

(11) Press **FIELD SELECT ↓** key to select **GEN 1 WAVE**, adjust **DATA SCROLL** knob to select **Sine**, and press **DATA ENTRY ENTER** key. Set multimeter to measure volts ac and record multimeter indication (approximately 3.1 V rms).

(12) Press **FIELD SELECT ↑** key to select **GEN 1** and press **DATA ENTRY ENTER** key to set **GEN 1 Off**.

(13) Press **FIELD SELECT ↓** key to select **GEN 2 WAVE**, adjust **DATA SCROLL** knob to select **Sine**, and press **DATA ENTRY ENTER** key. Press **FIELD SELECT ↑** key to select **GEN 2** and press **DATA ENTRY ENTER** key to set **GEN 2 On**.

(14) Adjust A24R85 (fig. 2) for a multimeter indication recorded in (11) above ± 5 mV (R).

(15) Disconnect multimeter and reconnect to TI and resistance standard set to 150 Ω .

(16) Press **MODE MTRS** key, **AUX (F6)** key, **DATA ENTRY** key 1 (Calibrations), and press **FIELD SELECT ↓** key to select **15. Func Gen Level**. Press **DATA ENTRY ENTER** and **DATA ENTRY 1** keys (199.9 mV calibration).

(17) Use **DATA SCROLL** controls to adjust multimeter indication for 199.0 ± 1 mV ac and press **DATA ENTRY ENTER**.

(18) Press **DATA ENTRY 2** key (2.5 V calibration), use **DATA SCROLL** controls to adjust multimeter indication for 2.500 ± 0.010 V ac then press **DATA ENTRY ENTER** key.

(19) Press **ESC (F6)** key, press **FIELD SELECT ↑** or **↓** key to highlight **8. VRMS Meter**, and press **DATA ENTRY ENTER** key.

(20) Press **DATA ENTRY ENTER** and use **DATA ENTRY** keys to enter multimeter indication to two decimal places, then press **DATA ENTRY ENTER** and **Ret (F5)** keys.

(21) Press **MODE AF GEN** (AF GEN Display) key; when prompted for backup data, press **SHIFT** and **Y** keys (Backup Cal Data ? y/n).

(22) Disconnect test equipment, press **TI POWER** key off, remove frequency generator assembly and extender card, and reinstall frequency generator assembly in proper slot. Press **TI POWER** key ON.

10. Distortion Meter

a. Performance Check

(1) Press key sequence listed in (a) through (f) below:

- (a) **MODE MTRS** Meters Menu
- (b) **AUX (F6)** Auxiliary Functions Menu
- (c) **MEMORY RCL** Recall Parameters Menu
- (d) **FIELD SELECT ↑** Highlight **10. Factory Defaults**
- (e) **DATA ENTRY ENTER** Factory Defaults recall

NOTE

Assure highlighted area indicates **YES** before proceeding.

- (f) **DATA ENTRY ENTER** Factory Defaults restored

(2) Connect equipment as shown in figure 3. Set audio analyzer source level to minimum, multimeter to measure volts ac, and press calibrator **WIDEBAND** key on.

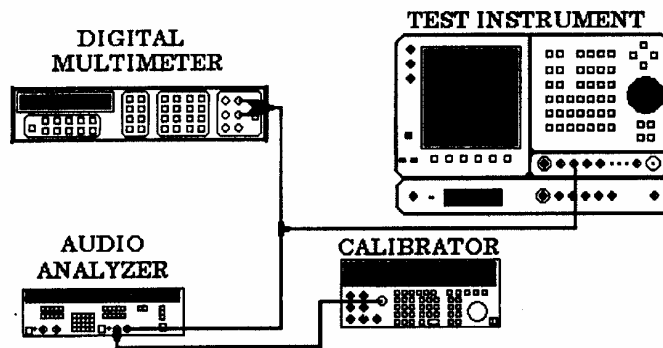

Figure 3. SINAD/distortion accuracy connection.

(3) Press key sequence listed in (a) through (m) below:

- (a) **MODE MTRS** Meter Menu
- (b) **DATA ENTRY 6** Dist Meter
- (c) **SETUP** Distortion Meter Menu

- (d) **DATA ENTRY 1** Select Dist In
- (e) **DATA ENTRY 2** SINAD/BER
- (f) **DATA ENTRY 4** Upper Lmt On
- (g) **DATA ENTRY 5** Set Upper Lmt
- (h) **DATA ENTRY 2 0 ENTER** 20.0%
- (i) **DATA ENTRY 9** Average On
- (j) **FIELD SELECT ↓** Highlight **10. Filter Select**
- (k) **DATA ENTRY ENTER** Low Pass Filter Freq
- (l) **DATA ENTRY 1 5 K** Low Pass Filter 15.000 kHz
- (m) **Ret (F5)** Return

(4) Set audio analyzer for 50 Ω (SPCL 75) output impedance, source frequency to 1 kHz, source level to 1 V, press **SOURCE FLOAT** key to illuminate, and record multimeter indication. Set audio analyzer source level to minimum

(5) Set calibrator frequency to 2400 Hz and amplitude for multimeter indication recorded in (4) above. Press calibrator **NEW REF** key.

(6) Set audio analyzer source level to 1 V and press calibrator **+10** key one time. If TI distortion meter does not indicate between 9.4 and 10.6 percent, perform **b** below.

(7) Set calibrator frequency to 3010 Hz and press calibrator **+10** key one time. TI distortion meter will indicate between .4 and 1.6 percent.

(8) Set calibrator frequency to 6030 Hz and press calibrator **X10** key twice. Use calibrator amplitude output adjustment controls to set calibrator control display **Error** to +82.42%. TI distortion meter will indicate between 15.7 and 19.9 percent.

b. Adjustments

(1) Press key sequence listed in (a) through (d) below:

- (a) **SETUP** Distortion Meter Menu
- (b) **AUX (F6)** Auxiliary Functions Menu
- (c) **DATA ENTRY 1** Calibrations
- (d) **DATA ENTRY 5** Distortion Meter

(2) Press **DATA ENTRY ENTER** key to highlight **Proper Reading** field. Enter **10** using **DATA ENTRY** keys and press **DATA ENTRY ENTER** key. Press **Ret (F5)** key.

(3) Press **MODE MTRS** (Meter Menu) key; when prompted for backup data, press **SHIFT** and **Y** keys (Backup Cal Data ? y/n).

11. SINAD Meter

a. Performance Check

(1) Connect equipment as shown in figure 3. Set audio analyzer source level to minimum, multimeter to measure volts ac, and press calibrator **WIDEBAND** key on.

- (2) Press key sequence listed in (a) through (f) below:
- (a) **MODE MTRS** Meters Menu
 - (b) **AUX (F6)** Auxiliary Functions Menu
 - (c) **MEMORY RCL** Recall Parameters Menu
 - (d) **FIELD SELECT ↑** Highlight **10. Factory Defaults**
 - (e) **DATA ENTRY ENTER** Factory Defaults recall

NOTE

Assure highlighted area indicates **YES** before proceeding.

- (f) **DATA ENTRY ENTER** Factory Defaults restored
- (3) Press key sequence listed in (a) through (i) below:

- (a) **MODE MTRS** Meter Menu
- (b) **DATA ENTRY 7** SINAD Meter
- (c) **SETUP** SINAD Meter Menu
- (d) **DATA ENTRY 1** Select SINAD In
- (e) **DATA ENTRY 2** SINAD/BER
- (f) **DATA ENTRY 8** Average On
- (g) **DATA ENTRY 9** Filter Select
- (h) **DATA ENTRY 1 5 K** Low Pass Filter Freq 15.000 kHz
- (i) **Ret (F5)** Return to SINAD METER

(4) Set audio analyzer for 50 Ω (SPCL 75) output impedance, source frequency to 1 kHz, source level to 1 V, press **SOURCE FLOAT** key to illuminate, record multimeter indication, then set audio analyzer source level to minimum.

(5) Set calibrator frequency to 2400 Hz, amplitude for multimeter indication recorded in (4) above and press calibrator **NEW REF** key.

(6) Set audio analyzer source level to 1 V.

(7) Use calibrator amplitude output adjustment controls to set calibrator control display **Error** to +66.7%. If TI SINAD meter does not indicate between 8.9 and 11.1 dB, perform **b** below.

(8) Set calibrator frequency to 4800 Hz. Use calibrator amplitude output adjustment controls to set calibrator control display **Error** to +25.8%. TI SINAD meter will indicate between 3.4 and 5.6 dB.

- (9) Press key sequence listed in (a) through (e) below:
- (a) **SETUP** SINAD Meter Menu
 - (b) **DATA ENTRY 9** Filter Select
 - (c) **DATA ENTRY ENTER** until display reads Low Pass Filter Freq

- (d) **DATA ENTRY 3 0 K**..... Low Pass Filter Freq 30.000 kHz
- (e) **Ret (F5)** Return to SINAD METER

(10) Set calibrator frequency to 9600 Hz. Use calibrator amplitude output adjustment controls to set calibrator control display **Error** to +96.242%. TI **SINAD** meter will indicate between 27.4 and 29.6 dB.

b. Adjustments

(1) Press key sequence listed in (a) through (d) below:

- (a) **SETUP** SINAD Meter Menu
- (b) **AUX (F6)** Auxiliary Functions Menu
- (c) **DATA ENTRY 1**..... Calibrations
- (d) **DATA ENTRY 6**..... Distortion Meter

(2) Press **DATA ENTRY ENTER** key to highlight **Proper Reading** field. Enter **10** using **DATA ENTRY** keys and press **DATA ENTRY ENTER** key. Press **Ret (F5)** key.

(3) Press **MODE MTRS** (Meter Menu) key; when prompted for backup data press **SHIFT** and **Y** keys (Backup Cal Data ? y/n).

12. Digital Multimeter

a. Performance Check

(1) Connect calibrator **OUTPUT HI** and **LO** to TI **DMM V/Ω** and **COM**.

(2) Press key sequence listed in (a) through (f) below:

- (a) **MODE MTRS** Meters Menu
- (b) **AUX (F6)** Auxiliary Functions Menu
- (c) **MEMORY RCL** Recall Parameters Menu
- (d) **FIELD SELECT ↑** Highlight **10. Factory Defaults**
- (e) **DATA ENTRY ENTER** Factory Defaults recall

NOTE

Assure highlighted area indicates **YES** before proceeding.

- (f) **DATA ENTRY ENTER** Factory Defaults restored

(3) Press key sequence listed in (a) through (c) below:

- (a) **MODE MTRS** Meters Menu
- (b) **FIELD SELECT ↑** Highlight **10. Digital Multimeter(DMM)**
- (c) **DATA ENTRY ENTER** Select Multimeter

(4) Press **Range (F2)** key, adjust **DATA SCROLL** knob to select TI range settings, press **DATA ENTRY ENTER** key, and set calibrator for output settings listed in table 6. TI multimeter indications will be within limits specified in table 6.

Table 6. AC Voltage

Test instrument range settings	Calibrator output settings		Test instrument multimeter indications	
	Amplitude	Frequency	Min	Max
200 mV	180 mV	1 kHz	169.9 mV	190.1 mV
2.0 V	1.0 V	50 Hz	0.899 V	1.101 V
2.0 V	1.0 V	100 Hz	0.899 V	1.101 V
2.0 V	1.0 V	1 kHz	0.899 V	1.101 V
2.0 V	1.0 V	10 kHz	0.899 V	1.101 V
2.0 V	1.0 V	20 kHz	0.899 V	1.101 V
2.0 V	1.8 V	1 kHz	1.699 V	1.901 V
20 V	18 V	1 kHz	16.99 V	19.01 V
200 V	180 V	100 Hz	169.9 V	190.1 V
2000 V ¹	470 V	100 Hz	369 V	571 V

¹After verification press **RESET** key on calibrator.

(5) Press **Func (F1)** key, adjust **DATA SCROLL** knob to select **DCV**, and press **DATA ENTRY ENTER** key.

(6) Press **Range (F2)** key, adjust **DATA SCROLL** knob to select TI range settings, press **DATA ENTRY ENTER** key, and set calibrator for output settings listed in table 7. TI multimeter indications will be within limits specified in table 7.

Table 7. DC Voltage

Test instrument range settings	Calibrator output settings	Test instrument multimeter indications	
		Min	Max
200 mV	190 mV	187.9 mV	192.1 mV
2.0 V	1.9 V	1.879 V	1.921 V
20 V	19 V	18.79 V	19.21 V
200 V	190 V	187.9 V	192.1 V
2000 V ¹	980 V	959 V	1001 V

¹After verification press **RESET** key on calibrator.

(7) Connect calibrator **OUTPUT HI** and **LO** to TI **AMP** and **COM**.

(8) Press **Func (F1)** key, adjust **DATA SCROLL** knob to select **DCC**, and press **DATA ENTRY ENTER** key.

(9) Press **Range (F2)** key, adjust **DATA SCROLL** knob to select TI range settings, press **DATA ENTRY ENTER** key, and set calibrator for output settings listed in table 8. TI multimeter indications will be within limits specified in table 8.

Table 8. DC Current

Test instrument range settings	Calibrator output settings	Test instrument multimeter indications	
		Min	Max
20 mA	18 mA	16.99 mA	19.01 mA
200 mA	180 mA	169.9 mA	190.1 mA
2 A	1.8 A	1.699 A	1.901 A
20 A ¹	5 A	3.99 A	6.01 A

¹Set calibrator to **STANDBY** and disconnect from TI. Connect current shunt (supplied with TI) to TI **DMM V/Ω** and **COM**. Connect calibrator amplifier **OUTPUT HI** and **LO** to current shunt inputs observing polarity. After verification set calibrator to **STANDBY**.

(10) Connect calibrator **OUTPUT HI** and **LO** to **DMM V/Ω** and **COM**.

(11) Press **Func (F1)** key, use **DATA SCROLL** controls to select **Ohm**, and press **DATA ENTRY ENTER** key.

(12) Press **RANGE (F2)** key, use **DATA SCROLL** controls to select TI range settings, press **DATA ENTRY ENTER** key, and set calibrator output for settings listed in table 9. At each setting, use calibrator output adjustment controls to set calibrator control display **Reading** equal to TI indication. Calibrator control display **Error** indications will be within limits specified in table 9.

Table 9. Ohms

Test instrument range settings	Calibrator	
	Output settings	Error indications (±%)
200 Ω	100 Ω ¹	10.1
2 kΩ	1 kΩ	10.1
20 kΩ	10 kΩ	10.1
200 kΩ	100 kΩ ²	10.1
2 MΩ	1 MΩ	10.1
20 MΩ	10 MΩ	10.1

¹Set calibrator **2 wire Comp** to **ON**.

²Set calibrator **2 wire Comp** to **OFF**.

b. Adjustments. No further adjustments can be made.

13. Generator Output Level

a. Performance Check

(1) Press key sequence listed in (a) through (f) below:

- (a) **MODE MTRS** Meters Menu
- (b) **AUX (F6)** Auxiliary Function Menu
- (c) **MEMORY RCL** Recall
- (d) **FIELD SELECT ↑** Highlight **10. Factory Defaults**
- (e) **DATA ENTRY ENTER** Factory Defaults recall

NOTE

Assure highlighted area indicates **YES** before proceeding.

- (f) **DATA ENTRY ENTER** Factory Defaults restored

NOTE

If necessary, perform measuring receiver zero and calibrate.

- (2) Connect measuring receiver sensor module to TI **T/R IN/OUT**.

- (3) Press key sequence listed in (a) through (h) below:

- (a) **MODE RF GEN** RF Gen Display
- (b) **SETUP** Gen Menu
- (c) **DATA ENTRY 5** RF Gen Setup
- (d) **DATA ENTRY 2** RF Gen Level
- (e) **DATA ENTRY 0 ENTER** 0 dBm
- (f) **DATA ENTRY 1** RF Gen Freq
- (g) **DATA ENTRY 3 0 M** 30 MHz
- (h) **Ret (F5)** Return

- (4) Set measuring receiver to measure RF power at 30 MHz.

- (5) Set measuring receiver to ratio mode.

(6) Press TI **DATA SCROLL** arrow keys to manually sweep TI frequency from 500 kHz to 399 MHz entering TI display frequency into measuring receiver. If measuring receiver indication does not remain within ± 2.0 dB, perform **b** below.

(7) Press TI **DATA SCROLL** arrow keys to manually sweep TI frequency from 400 MHz to 999 MHz entering TI display frequency into measuring receiver. If measuring receiver indication does not remain within ± 3.5 dB, perform **b** below.

(8) Set TI frequency to 30 MHz. Set measuring receiver to acquire frequency then to measure tuned rf power and perform measuring receiver calibrate.

NOTE

Perform measuring receiver calibration as necessary.

(9) Press TI **Level (F3)** (dBm display) key and adjust output level for the following dBm indications : 0, -1, -2, -4, -8, -16, -32 and -64. Measuring receiver indications will be within ± 2.0 dBm of TI indications.

(10) Adjust output level from -90 dBm to -110 dBm in 10 dB steps. Measuring receiver indications will be within ± 2.5 dBm of TI indications.

b. Adjustments

(1) Press key sequence listed in (a) through (l) below:

- (a) **MODE MTRS** Meter Menu
- (b) **AUX (F6)** Auxiliary Functions Menu
- (c) **MEMORY RCL** Recall
- (d) **FIELD SELECT ↑** Highlight **10. Factory Defaults**
- (e) **DATA ENTRY ENTER**..... Factory Defaults recall

NOTE

Assure highlighted area indicates **YES** before proceeding.

- (f) **DATA ENTRY ENTER**..... Factory Defaults restored
- (g) **MODE RF GEN** RF Gen Display
- (h) **SETUP** Gen Menu
- (i) **DATA ENTRY 5** RF Gen Setup
- (j) **DATA ENTRY 2** RF Gen Level
- (k) **DATA ENTRY 0 ENTER** 0 dBm
- (l) **ESC (F6)**..... Escape

(2) Press key sequence listed in (a) through (d) below:

- (a) **AUX (F6)** Auxiliary Function Menu
- (b) **DATA ENTRY 1** Calibration
- (c) **FIELD SELECT ↑** Highlight **14. Gen Output Level**
- (d) **DATA ENTRY ENTER** twice Select Option

(3) Use (F1) key to toggle between "HIGH" and "LOW" ends of each range of frequencies and record the two levels appearing on measuring receiver. Algebraically subtract the two levels of each frequency range to verify levels are balanced. If not, adjust **DATA SCROLL** knob and press arrow keys to adjust for a balance, then press **DATA ENTRY ENTER** key to store new cal factors. Verify new cal factors by toggling between "HIGH" and "LOW" for each frequency range adjusted.

(4) Press **FIELD SELECT** arrow key to select the next option (example: **2. 500 kHz**) and repeat (3) above.

(5) Repeat (4) above for each **Gen Level Calibration** option shown on TI.

(6) Press **MODE RF GEN** (RF GEN Display) key; when prompted for backup data, press **SHIFT** and **Y** keys (Backup Cal Data ? y/n).

(7) Press **ESC (F6)** key.

14. Generator Spectral Purity

a. Performance Check

(1) Press key sequence listed in (a) through (f) below:

- (a) **MODE MTRS** Meters Menu
- (b) **AUX (F6)** Auxiliary Function Menu
- (c) **MEMORY RCL** Recall
- (d) **FIELD SELECT ↑** Highlight **10. Factory Defaults**
- (e) **DATA ENTRY ENTER** Factory Defaults recall

NOTE

Assure highlighted area indicates **YES** before proceeding.

- (f) **DATA ENTRY ENTER** Factory Defaults restored

(2) Connect spectrum analyzer **INPUT 50Ω** to TI **T/R IN/OUT**.

(3) Press key sequence listed in (a) through (e) below:

- (a) **MODE RF GEN** RF Gen Display
- (b) **Freq (F2)** RF Frequency
- (c) **DATA ENTRY 1 M** 1 MHz
- (d) **Level (F3)** RF Level
- (e) **DATA ENTRY 0 ENTER** 0 dBm

(4) Verify all spurious response across the band are more than 26 dBc down for harmonics and more than 50 dBc down for nonharmonics.

(5) Repeat (3) (b), (c), and (4) above for frequencies of 10, 100, 200, 300, 400, 500, 600, 700, 800, and 900 MHz.

(6) Enter **500 K** using TI **DATA ENTRY** keys.

NOTE

Brackets around a key callout denotes a softkey.

(7) Press spectrum analyzer key sequence listed in (a) through (m) below:

- (a) **PRESET** to reset spectrum analyzer
- (b) **FREQUENCY Channel** Frequency menu
- (c) **[Center Freq] 500 kHz** 500 kHz
- (d) **SPAN X Scale** Span menu
- (e) **[SPAN] 50 kHz** 50 kHz
- (f) **BW/Avg** BW menu
- (g) **[Res BW] 100 Hz** 100 Hz Resolution Bandwidth

- (h) **[Video BW] 100 Hz**..... 100 Hz Video Bandwidth
- (i) **PEAK SEARCH** Activate reference marker
- (j) **MARKER** Marker menu
- (k) **[MORE]** Next page
- (l) **[Function]** Function menu
- (m) **[Marker Noise]**..... On

(8) Set frequency to 480 kHz on spectrum analyzer and wait for several scans. Spectrum analyzer will indicate <-80 dB (1 Hz).

(9) Set frequency to 520 kHz on spectrum analyzer and wait for several scans. Spectrum analyzer will indicate <-80 dB (1 Hz).

(10) Enter **950 K** using TI **DATA ENTRY** keys.

(11) Repeat (7) above except use a frequency of 950 kHz.

(12) Set frequency to 930 kHz on spectrum analyzer and wait for several sweeps. Spectrum analyzer will indicate <-80 dB (1 Hz).

(13) Set frequency to 970 kHz on the spectrum analyzer and wait for several sweeps. Spectrum analyzer will indicate <-80 dB (1 Hz).

(14) Enter **1.1 M** using TI **DATA ENTRY** keys.

(15) Repeat (7) above except use a frequency of 1.1 MHz.

(16) Set frequency to 1.08 MHz on spectrum analyzer and wait for several sweeps. Spectrum analyzer will indicate <-90 dB (1 Hz).

(17) Set frequency to 1.12 MHz on spectrum analyzer and wait for several sweeps. Spectrum analyzer will indicate <-90 dB (1 Hz).

(18) Enter **40 M** using TI **DATA ENTRY** keys.

(19) Repeat (7) above except use a frequency of 40 MHz.

(20) Set frequency to 39.98 MHz on spectrum analyzer and wait for several sweeps. Spectrum analyzer will indicate <-90 dB (1 Hz).

(21) Set frequency to 40.02 MHz on spectrum analyzer and wait for several sweeps. Spectrum analyzer will indicate <-90 dB (1 Hz).

(22) Enter **925 M** using TI **DATA ENTRY** keys.

(23) Repeat (7) above except use a frequency of 925 MHz.

(24) Set frequency to 924.98 MHz on spectrum analyzer and wait for several sweeps. Spectrum analyzer will indicate <-90 dB (1 Hz).

(25) Set frequency to 925.02 MHz on spectrum analyzer and wait for several sweeps. Spectrum analyzer will indicate <-90 dB (1 Hz).

(26) Enter **935 M** using TI **DATA ENTRY** keys.

(27) Repeat (7) above except use a frequency of 935 MHz.

(28) Set frequency to 934.98 MHz on spectrum analyzer and wait for several sweeps. Spectrum analyzer will indicate <-85 dB (1 Hz).

(29) Set frequency to 935.02 MHz on spectrum analyzer and wait for several sweeps. Spectrum analyzer will indicate <-85 dB (1 Hz).

b. Adjustments. No further adjustments can be made.

15. Generator Residuals

a. Performance Check

(1) Press key sequence listed in (a) through (f) below:

- (a) **MODE MTRS** Meters Menu
- (b) **AUX (F6)** Auxiliary Functions Menu
- (c) **MEMORY RCL** Recall Parameters Menu
- (d) **FIELD SELECT ↑** Highlight **10. Factory Defaults**
- (e) **DATA ENTRY ENTER** Factory Defaults recall

NOTE

Assure highlighted area indicates **YES** before proceeding.

(f) **DATA ENTRY ENTER** Factory Defaults recall

(2) Connect measuring receiver sensor module to TI **T/R IN/OUT**.

(3) Set measuring receiver as listed in (a) through (e) below:

- (a) **INSTR PRESET**.
- (b) **FM** deviation.
- (c) **50 Hz HIGH PASS** filter.
- (d) **15 kHz LOW PASS** filter.
- (e) **RMS** detector.

(4) Press key sequence listed in (a) through (h) below:

- (a) **MODE RF GEN** RF Gen Display
- (b) **SETUP** Gen Menu
- (c) **DATA ENTRY 5** RF Gen Setup
- (d) **DATA ENTRY 2** RF Gen Level
- (e) **DATA ENTRY 0 ENTER** 0 dBm
- (f) **DATA ENTRY 1** RF Gen Freq
- (g) **DATA ENTRY 1 M** 1 MHz
- (h) **Ret (F5)** Return

(5) Measuring receiver FM indication will be <45 Hz.

(6) Enter **9 9 . 9 9 9 M** using TI **DATA ENTRY** keys.

(7) Measuring receiver FM indication will be <45 Hz.

(8) Enter **5 0 0 M** using TI **DATA ENTRY** keys.

- (9) Measuring receiver FM indication will be <140 Hz.
- (10) Enter **9 9 9 M** using TI **DATA ENTRY** keys.
- (11) Measuring receiver FM indication will be <140 Hz.
- (12) Set measuring receiver to measure AM.
- (13) Enter **1 M** using TI **DATA ENTRY** keys.
- (14) Measuring receiver AM indication will be <0.10%.
- (15) Step TI frequency in 100 MHz increments from 100 MHz to 999.9999 MHz using technique of (13) above. Measuring receiver AM indications will be <0.10%.

b. Adjustments. No further adjustments can be made.

16. Generator Frequency

a. Performance Check

- (1) Press key sequence listed in (a) through (f) below:
 - (a) **MODE MTRS** Meters Menu
 - (b) **AUX (F6)** Auxiliary Functions Menu
 - (c) **MEMORY RCL** Recall Parameters Menu
 - (d) **FIELD SELECT ↑** Highlight **10. Factory Defaults**
 - (e) **DATA ENTRY ENTER** Factory Defaults recall

NOTE

Assure highlighted area indicates **YES** before proceeding.

- (f) **DATA ENTRY ENTER** Factory Defaults restored
- (2) Connect frequency counter **A** input to TI **T/R IN/OUT**.
- (3) Press key sequence listed in (a) through (h) below:
 - (a) **MODE RF GEN** RF Gen Display
 - (b) **SETUP** Gen Menu
 - (c) **DATA ENTRY 5** RF Gen Setup
 - (d) **DATA ENTRY 2** RF Gen Level
 - (e) **DATA ENTRY 0 ENTER** 0 dBm
 - (f) **DATA ENTRY 1** RF Gen Freq
 - (g) **DATA ENTRY 5 0 0 K** 500 kHz
 - (h) **Ret (F5)** Return
- (4) Frequency counter will indicate within limits listed in table 10.
- (5) Press TI **DATA SCROLL** arrow keys to set **MODE RF GEN** frequency to settings listed in table 10. Frequency counter indications will be within limits specified in table 10.

Table 10. RF GEN Frequency Accuracy

Test instrument frequency settings (MHz)	Frequency counter indications	
	Min	Max
0.500	499.99975 kHz	500.00025 kHz
1.0	999.9995 kHz	1.0000005 MHz
10.0	9.999995 MHz	10.000005 MHz
100.0 ¹	99.999950 MHz	100.000050 MHz
500.0 ²	499.999750 MHz	500.000250 MHz
999.0	998.999500 MHz	999.000500 MHz

¹Set frequency counter A input to 50 Ω.

²Move connection from frequency counter A input to C input.

b. Adjustments

(1) Press key sequence listed in (a) through (f) below:

- (a) **MODE MTRS** Meters Menu
- (b) **AUX (F6)** Auxiliary Function Menu
- (c) **MEMORY RCL** Recall
- (d) **FIELD SELECT ↑** Highlight **10. Factory Defaults**
- (e) **DATA ENTRY ENTER** Factory Defaults recall

NOTE

Assure highlighted area indicates **YES** before proceeding.

- (f) **DATA ENTRY ENTER** Factory Defaults restored

(2) Connect frequency counter **C** input to TI **T/R IN/OUT**.

(3) Press key sequence listed in (a) through (h) below:

- (a) **MODE RF GEN** RF Gen Display
- (b) **SETUP** Gen Menu
- (c) **DATA ENTRY 5** RF Gen Setup
- (d) **DATA ENTRY 2** RF Gen Level
- (e) **DATA ENTRY 0 ENTER** 0 dBm
- (f) **DATA ENTRY 1** RF Gen Freq
- (g) **DATA ENTRY 9 0 0 M** 900 MHz
- (h) **Ret (F5)** Return

NOTE

When performing the following softcal adjustment the fine adjustment range maybe exceeded. If this occurs the VXCO will need to be manually adjusted. If adjustment range is <0 or >4095, set Select Attn field to 2048 then remove the screw on top of the 10 Mhz Frequency Standard (which is located towards the top/back of the TI next to the Power Supply) and adjust the coarse frequency adjustment to 900 Mhz. The softcal adjustment may now be performed. Also, before performing the preceeding adjustment the TI should be temperature stable for at least 2 hours.

- (4) Press key sequence listed in (a) through (h) below:
 - (a) **SETUP** Gen Menu
 - (b) **AUX (F6)** Auxiliary Functions Menu
 - (c) **DATA ENTRY ENTER** Access Calibration Menu
 - (d) **FIELD SELECT**..... Select **12. VCXO Calibration**
 - (e) **DATA SCROLL** arrow..... to move cursor to least significant digit
 - (f) **DATA SCROLL** arrow..... to adjust for 900 MHz on frequency counter
 - (g) **DATA ENTRY ENTER** to enter new frequency calibration factor
 - (h) **Ret (F5)** Return

(5) Press **MODE RF GEN** key (RF GEN Display), when prompted for backup data press **SHIFT** and **Y** keys (Backup Cal Data ? y/n).

17. Oscilloscope

a. Performance Check

- (1) Press key sequence listed in (a) through (f) below:
 - (a) **MODE MTRS** Meters Menu
 - (b) **AUX (F6)** Auxiliary Functions Menu
 - (c) **MEMORY RCL** Recall Parameters Menu
 - (d) **FIELD SELECT** ↑ Highlight **10. Factory Defaults**
 - (e) **DATA ENTRY ENTER** Factory Defaults recall

NOTE

Assure highlighted area indicates **YES** before proceeding.

- (f) **DATA ENTRY ENTER** Factory Defaults restored
- (2) Press key sequence listed in (a) through (k) below:
 - (a) **MODE SCOPE/ANAL** SCOPE Display

- (b) **SETUP** Scope/Analyzer Menu
- (c) **DATA ENTRY 1** Scope On
- (d) **DATA ENTRY 3** Setup Scope
- (e) **DATA ENTRY 1** Input
- (f) **DATA ENTRY 7** AC
- (g) **DATA ENTRY 2** Trigger Source Internal
- (h) **DATA ENTRY 3** Sweep Rate
- (i) **DATA SCROLL** ↓ Highlight 1 ms
- (j) **DATA ENTRY ENTER** 1 ms sweep
- (k) **Ret (F5)** Return

(3) Connect calibrator **OUTPUT HI** and **LO** to **TI SCOPE IN**.

(4) For TI scale settings listed in table 11, press **Scale (F1)** key, adjust **DATA SCROLL** knob to select TI scale settings, press **DATA ENTRY ENTER** key, set calibrator frequency to 1 kHz, and amplitude for 5 divisions of vertical deflection on TI. Calibrator amplitude will be within limits specified in table 11.

NOTE

If necessary, press **Vert (F2)** key and use **DATA SCROLL** controls to position waveform vertically on display.

Table 11. Vertical Deflection Accuracy

Test instrument Scale settings	Calibrator indications			
	Min		Max	
2 mV	2.9694	mV	4.1006	mV
5 mV	8.1305	mV	9.5445	mV
10 mV	16.261	mV	19.089	mV
20 mV	32.522	mV	38.178	mV
50 mV	81.305	mV	95.445	mV
100 mV	162.61	mV	190.89	mV
200 mV	325.22	mV	381.78	mV
500 mV	813.05	mV	954.45	mV
1 V	1.6261	V	1.9089	V
2 V	3.2522	V	3.8178	V
5 V	8.1305	V	9.5445	V
10 V	16.261	V	19.089	V
20 V	32.522	V	38.178	V
50 V	81.305	V	95.445	V

(5) Connect oscilloscope calibrator **SOURCE/MEASURE CHAN 1** to **TI SCOPE IN** using 50 Ω feedthrough termination.

(6) Press **Sweep (F3)** key, adjust **DATA SCROLL** knob to select 20 μs, and press **DATA ENTRY ENTER** key.

(7) Press **Scale (F1)** key, adjust **DATA SCROLL** knob to select 10 mV, and press **DATA ENTRY ENTER** key.

NOTE

If necessary, press **Vert (F2)** key and use **DATA SCROLL** controls to position waveform vertically on display.

(8) Set oscilloscope calibrator level sine output for 50 kHz and 6 divisions of vertical deflection on TI.

(9) Set oscilloscope calibrator leveled sine wave frequency to 1 MHz. Press **Sweep (F3)** key and use **DATA SCROLL** controls, as necessary, to view waveform. Displayed waveform will be greater than 4.2 divisions.

(10) Repeat technique of (6) through (9) above for **Scale** 100 mV.

NOTE

For (11) through (15) below; press **Scale (F1)** key, use **DATA SCROLL** controls to set convenient display amplitude, press **Vert (F2)** key, and use **DATA SCROLL** controls to position markers vertically on display as necessary.

(11) Press **Sweep (F3)** key, adjust **DATA SCROLL** knob to select 1 μ s, and press **DATA ENTRY ENTER** key.

(12) Set oscilloscope calibrator markers output for 1 μ s.

(13) Press **Horiz (F4)** key and adjust **DATA SCROLL** knob to align 1st marker with 1st vertical graticule line on TI.

(14) Use oscilloscope calibrator output adjustment controls to align 11th marker with 11th vertical graticule line on TI. Oscilloscope calibrator **Err** indication will be within $\pm 3\%$.

(15) Repeat technique of (11) through (15) above for remaining TI and calibrator settings listed in table 12. Oscilloscope calibrator **Err** indications will be within $\pm 3\%$.

Table 12. Horizontal Time Accuracy

Test instrument sweep settings	Oscilloscope calibrator markers settings
5 μ s	5 μ s
10 μ s	10 μ s
20 μ s	20 μ s
50 μ s	50 μ s
100 μ s	100 μ s
200 μ s	200 μ s
500 μ s	500 μ s
1 ms	1 ms
2 ms	2 ms
5 ms	5 ms
10 ms	10 ms

Table 12. Horizontal Time Accuracy - Continued

Test instrument Sweep settings	Oscilloscope calibrator Markers settings
20 ms	20 ms
50 ms	50 ms
100 ms	100 ms

b. Adjustments. No further adjustments can be made.

18. Spectrum Analyzer

a. Performance Check

(1) Press key sequence listed in (a) through (g) below:

- (a) **MODE MTRS** Meters Menu
- (b) **AUX (F6)** Auxiliary Functions Menu
- (c) **MEMORY RCL** Recall Parameters Menu
- (d) **FIELD SELECT ↑** Highlight **10. Factory Defaults**
- (e) **DATA ENTRY ENTER** Factory Defaults recall

NOTE

Assure highlighted area indicates **YES** before proceeding.

- (f) **DATA ENTRY ENTER** Factory Defaults restored
- (g) **MODE SCOPE/ANAL** twice ... Spectrum Analyzer screen

NOTE

Pressing **More (F6)** key will scroll various options on the bottom of the display. The options will change the functions assigned to the **F1** through **F6** function keys. This may be necessary to obtain the **Freq (F1)**, **Scan (F3)**, **Gen 1 (F2)**, **Res bw (F1)**, and **Gen 0 (F2)** options required in the following tests.

(2) Connect signal generator **RF OUPUT** to **TI ANTENNA** and measuring receiver sensor module using power splitter.

(3) Press **ATTEN (F4)** and **DATA SCROLL** arrow keys to set 40 dB, then press **DATA ENTRY ENTER** key. Set signal generator for a 10 MHz, 6.1 dB output with no modulation.

(4) Press **Freq (F1)** (RF Frequency Display) key, adjust the **DATA SCROLL** knob, and press arrow keys to set **TI ANALYZER RF** frequency to match signal generator frequency initial setting. Press **DATA ENTRY ENTER** key.

(5) Press **Scan (F3)** (Scan Width) key, adjust **DATA SCROLL** knob, and press arrow keys to set TI scan rate to 1 kHz. Press **DATA ENTRY ENTER** key.

(6) If displayed signal peak is not centered on center vertical graticule line, perform **b** (1) through (11) below.

(7) Set measuring receiver to measure frequency. Enter signal generator initial setting into measuring receiver and press **MHz** key. Adjust signal generator frequency to position TI display signal peak on center vertical graticule line, set measuring receiver to measure **FREQ ERROR**, and press **MHz** (INPUT FREQ) key.

(8) Decrease signal generator frequency until displayed signal peak is centered on second vertical graticule line. If measuring receiver does not indicate within limits specified in table 13, perform **b** (1) through (11) below.

(9) Increase signal generator frequency until displayed signal peak is centered on tenth vertical graticule line. If measuring receiver does not indicate within limits specified in table 13, perform **b** (1) through (11) below.

Table 13. Scan Width Accuracy

Signal generator No. 1 initial setting	Measuring receiver indications		Test instrument	
	Min (kHz)	Max (kHz)	Settings scan	Graticule indication
10 MHz	-3.5	-4.5	1 kHz	2d
10 MHz	3.5	4.5	1 kHz	10th
10 MHz	-7.0	-9.0	2 kHz	2d
10 MHz	7.0	9.0	2 kHz	10th
20 MHz	-17.5	-22.5	5 kHz	2d
20 MHz	17.5	22.5	5 kHz	10th
20 MHz	-35.0	-45.0	10 kHz	2d
20 MHz	35.0	45.0	10 kHz	10th
20 MHz	-70.0	-90.0	20 kHz	2d
20 MHz	70.0	90.0	20 kHz	10th
100 MHz	-175.0	-225.0	50 kHz	2d
100 MHz	175.0	225.0	50 kHz	10th
100 MHz	-350.0	-450.0	100 kHz	2d
100 MHz	350.0	450.0	100 kHz	10th
100 MHz	-700.0	900.0	200 kHz	2d
100 MHz	700.0	900.0	200 kHz	10th
200 ¹ MHz	-1750.0	-2250.0	500 kHz	2d
200 MHz	1750.0	2250.0	500 kHz	10th
200 MHz	-2500.0	-3500.0	1 MHz	3d
200 MHz	2500.0	3500.0	1 MHz	9th

¹Set measuring receiver **TRACK MODE** on.

(10) Press **FIELD SELECT** keys to select **Freq** and **Scan** functions and press **DATA SCROLL** arrow keys. Adjust **DATA SCROLL** knob to set **Scan** and **Freq** remaining values. Repeat (3) through (5) and (7) through (9) above for remaining settings listed in table 13.

(11) Press key sequence listed in (a) through (g) below:

(a) **MODE MTRS** Meters Menu

- (b) **AUX (F6)** Auxiliary Function Menu
- (c) **MEMORY RCL** Recall
- (d) **FIELD SELECT ↑** Highlight **10. Factory Defaults**
- (e) **DATA ENTRY ENTER** Factory Defaults recall

NOTE

Assure highlighted area indicates **YES** before proceeding.

- (f) **DATA ENTRY ENTER** Factory Defaults restored
 - (g) **SCOPE/ANLZ** twice Analyzer Display
- (12) Press key sequence listed in (a) through (n) below:
- (a) **SETUP** Scope/Analyzer Menu
 - (b) **DATA ENTRY 2** Analyzer On
 - (c) **DATA ENTRY 4** Setup Analyzer
 - (d) **DATA ENTRY 2** Frequency
 - (e) **DATA ENTRY 1 M** 1 MHz
 - (f) **DATA ENTRY 4** Input Atten
 - (g) **DATA ENTRY 3** 40 dB
 - (h) **DATA ENTRY 6** Scan Width
 - (i) **DATA SCROLL ↓** Highlight **5 kHz**
 - (j) **DATA ENTRY ENTER** Select 5 kHz Scan Width
 - (k) **FIELD SELECT ↓** Highlight **10. Velocity Factor**
 - (l) **DATA ENTRY ENTER** Select Velocity Factor
 - (m) **DATA ENTRY 1 0 0 ENTER** 100%
 - (n) **Ret (F5)** Return

(13) Disconnect signal generator from TI **ANTENNA**. Press **Norm (F1)** key and allow time for normalize cycle to complete.

(14) Connect signal generator **RF OUPUT** to variable attenuator input. Connect variable attenuator output to TI **ANTENNA**.

(15) Set variable attenuator to 0 dB, signal generator frequency to 1 MHz and amplitude for a 0 dB TI indication.

(16) Set variable attenuator from 0 to 40 dB in 10 dB steps. TI indication will be within ±4 dB of variable attenuator test report values.

(17) Press **Atten (F4)** (RF ATTEN) key and press **DATA SCROLL ↑** key until **RF ATTEN** indicates **0 dB** and repeat (13) and (14) above.

(18) Set variable attenuator from 40 to 80 dB in 10 dB steps. If TI indications are not within ± 4 dB of variable attenuator test report values, perform **b** (12) through (33) below.

(19) Press key sequence listed in (a) through (g) below:

- (a) **SETUP** Scope/Analyzer Menu
- (b) **DATA ENTRY 4** Setup Analyzer
- (c) **DATA ENTRY 2** Frequency
- (d) **DATA ENTRY 3 5 0 M** 350 MHz
- (e) **DATA ENTRY 4** Input Atten
- (f) **DATA ENTRY 3** 40 dB
- (g) **Ret (F5)** Return

(20) Set variable attenuator to 0 dB, signal generator frequency to 350 MHz and amplitude for a 0 dB TI indication.

(21) Temporarily disconnect signal generator from TI **ANTENNA**, press **Norm (F1)** (Normalize) key, and reconnect after allowing time for normalize cycle to complete. If necessary, adjust signal generator amplitude for a 0 dB TI indication.

(22) Repeat technique of steps (16) through (18) above.

(23) Press key sequence listed in (a) through (g) below:

- (a) **SETUP** Scope/Analyzer Menu
- (b) **DATA ENTRY 4** Setup Analyzer
- (c) **DATA ENTRY 2** Frequency
- (d) **DATA ENTRY 4 5 0 M** 450 MHz
- (e) **DATA ENTRY 4** Input Atten
- (f) **DATA ENTRY 3** 40 dB
- (g) **Ret (F5)** Return

(24) Set variable attenuator to 0 dB, signal generator frequency to 450 MHz and amplitude for a 0 dB TI indication.

(25) Temporarily disconnect signal generator from TI **ANTENNA**, press **Norm (F1)** (Normalize) key, and reconnect after allowing time for normalize cycle to complete. If necessary, adjust signal generator amplitude for a 0 dB TI indication.

(26) Repeat technique of steps (16) through (18) above. TI indications will be within ± 5 dB of variable attenuator test report values.

(27) Press key sequence listed in (a) through (g) below:

- (a) **SETUP** Scope/Analyzer Menu
- (b) **DATA ENTRY 4** Setup Analyzer
- (c) **DATA ENTRY 2** Frequency
- (d) **DATA ENTRY 9 5 0 M** 950 MHz

- (e) **DATA ENTRY 4** Input Atten
- (f) **DATA ENTRY 3** 40 dB
- (g) **Ret (F5)** Return

(28) Set variable attenuator to 0 dB, signal generator frequency to 950 MHz and amplitude for a 0 dB TI indication.

(29) Temporarily disconnect signal generator from TI **ANTENNA**, press **Norm (F1)** (Normalize) key. Reconnect after allowing time for normalize cycle to complete. If necessary, adjust signal generator amplitude for a 0 dB TI indication.

(30) Repeat technique of steps (16) through (18) above. TI indications will be within ± 5 dB of variable attenuator test report values.

(31) Disconnect signal generator and variable attenuator from TI.

(32) Press key sequence listed in (a) through (g) below:

- (a) **MODE MTRS** Meters Menu
- (b) **AUX (F6)** Auxiliary Function Menu
- (c) **MEMORY RCL** Recall
- (d) **FIELD SELECT ↑** Highlight **10. Factory Defaults**
- (e) **DATA ENTRY ENTER** Factory Defaults recall

NOTE

Assure highlighted area indicates **YES** before proceeding.

- (f) **DATA ENTRY ENTER** Factory Defaults restored
- (g) **SCOPE/ANLZ** twice Analyzer Display

(33) Press key sequence listed in (a) through (j) below:

- (a) **SETUP** Scope/Analyzer Menu
- (b) **DATA ENTRY 2** Analyzer On
- (c) **DATA ENTRY 4** Setup Analyzer
- (d) **DATA ENTRY 2** Frequency
- (e) **DATA ENTRY 1 2 1 . 5 M** 121.5 MHz
- (f) **DATA ENTRY 5** Range 2 dB
- (g) **DATA ENTRY 6** Scan Width
- (h) **DATA SCROLL ↓** Highlight **100 kHz**
- (i) **DATA ENTRY ENTER** Select 100 kHz Scan Width
- (j) **Ret (F5)** Return

(34) Connect signal generator **RF OUPUT** to **ANTENNA** and set signal generator for a 121.5 MHz, -40 dBm output.

(35) Press **(F4)** (Ref lvl) and **DATA SCROLL** arrow keys to place signal peak to approximately center of display.

(36) Press **(F3)** (Scan) and **DATA SCROLL** arrow keys to select **1 kHz** scan width. Press **DATA ENTRY ENTER** key. Displayed signal peak will be within 3 dBm of center reference established in (35) above.

(37) Press **(F3)** (Scan) and **DATA SCROLL** arrow keys to select **10 kHz** scan width. Press **DATA ENTRY ENTER** key. Displayed signal peak will be within 2 dBm of center reference established in (35) above.

(38) Press **(F3)** (Scan) and **DATA SCROLL** arrow keys to select **1 MHz** scan width. Press **DATA ENTRY ENTER** key. Displayed signal peak will be within 2 dBm of center reference established in (35) above.

(39) Press **(F3)** (Scan) and the **DATA SCROLL** arrow keys to select **50 MHz** scan width. Press **DATA ENTRY ENTER** key. Displayed signal peak will be within 3 dBm of center reference established in (35) above.

b. Adjustments

(1) Set signal generator **RF** off.

(2) Press key sequence listed in (a) through (f) below:

- (a) **MODE MTRS** Meters Menu
- (b) **AUX (F6)** Auxiliary Function Menu
- (c) **MEMORY RCL** Recall
- (d) **FIELD SELECT ↑** Highlight **10. Factory Defaults**
- (e) **DATA ENTRY ENTER** Factory Defaults recall

NOTE

Assure that the highlighted area indicates **YES** before proceeding to next step.

(f) **DATA ENTRY ENTER** Factory Defaults restored

(3) Press key sequence listed in (a) through (f) below:

- (a) **MODE RF GEN** RF Generator Display
- (b) **F1 (Disp)** Displays Menu
- (c) **2 (Full Anlz)** Full Analyzer Display
- (d) **F3 (Level)** Select Level Display
- (e) **DATA ENTRY 0 ENTER** 0 dB level
- (f) **F5 (Scan)** Select Scan Display

(4) Press **DATA SCROLL** arrow keys to toggle between 20 kHz and 200 kHz while adjusting ANALYZER RF A5 ANALZR CENTER (fig. 1) for best centered compromise.

(5) Press key sequence listed in (a) through (h) below:

- (a) **FIELD SELECT ↑** Highlight **SOURCE**
- (b) **DATA SCROLL** arrow Set MOD to FM

- (c) **DATA ENTRY ENTER** Select **FM**
- (d) **FIELD SELECT** ↑ Highlight **DEVIATION**
- (e) **DATA ENTRY 6 5 K** 65 kHz deviation
- (f) **FIELD SELECT** ↑ Highlight **AF FREQ**
- (g) **DATA ENTRY 2 0 K** 20 kHz mod rate
- (h) **F5 (Scan)** Select scan

(6) Press **DATA SCROLL** arrow keys to toggle between 10 kHz and 20 kHz while adjusting ANALYZER RF A5 DISP ADJUST (fig. 1) for the best dispersion compromise.

(7) Press the **DATA SCROLL** arrow keys to set scan width to 1 kHz.

(8) Press **MODE MTRS** (Meters Menu), **AUX (F6)** (Auxiliary Functions Menu), and **DATA ENTRY ENTER** keys.

(9) Press the **FIELD SELECT** arrow keys to highlight **16. Anlz Horz Offset** and press **DATA ENTRY ENTER** key.

(10) Press **DATA ENTRY 3 5** and **ENTER** keys (set horizontal offset to 35).

NOTE

Decreasing the points offset will move the trace right,
increasing the points offset will move the trace left.

(11) Press **MODE SCOPE/ANLZ** (Analyzer Display), **DATA ENTRY SHIFT**, and **Y** (Backup Cal Data ? y/n) keys. Set signal generator **RF** on. Press the **FIELD SELECT** arrow keys to select **RF ATTEN** and **DATA SCROLL** to select 40 dB and press the **DATA ENTRY ENTER** key. Verify trace is centered within ±1 minor division. If not repeat steps (8) through (10) above increasing/decreasing the value entered as the points offset value in (10) above.

(12) Set signal generator for a 121.1 MHz, -40 dB output.

(13) Press the key sequence listed in (a) through (j) below:

- (a) **MODE SCOPE/ANAL** Analyzer Display
- (b) **SETUP** Scope/Analyzer Menu
- (c) **DATA ENTRY 2** Analyzer On
- (d) **DATA ENTRY 4** Setup Analyzer
- (e) **DATA ENTRY 2** Frequency
- (f) **DATA ENTRY 1 2 1 . 1 M** 121.1 Mhz
- (g) **DATA ENTRY 6** Scan Width
- (h) **FIELD SELECT** ↑ to select 100 kHz
- (i) **DATA ENTRY ENTER** Select 100 kHz Scan Width
- (j) **Ret (F5)** Return

(14) Press **TI POWER** key to off. Remove A25 digitizer module (fig. 1) and reinstall on extender card.

- (15) Connect SMB-to-SMB extender coax in place of cable 23 on A4 module (fig. 1) and press **POWER** key (**ON** illuminated).
- (16) Set signal generator for a 10.7 MHz, -30 dB output.
- (17) Connect multimeter to A25 J2 pin 8B (fig. 4) on digitizer module and set multimeter to measure volts dc.
- (18) Adjust A4R5 (fig. 1) on Log-IF board until multimeter indicates 1.4 V dc \pm 20 mV dc (R).
- (19) Press **Norm (F1)** (Normalize) key, allow normalize cycle to complete, and reconnect cable 23 on A4 module (fig. 1) to its original position.
- (20) Set signal generator for a 121.5 MHz, -40 dB output and verify signal peak is within \pm 1 dB of -40 dBm; readjust A4R5 (fig. 1) as necessary.
- (21) Press **Scan (F3)** (Scan Width) and **DATA SCROLL** arrow keys to select **50 kHz** scan width.

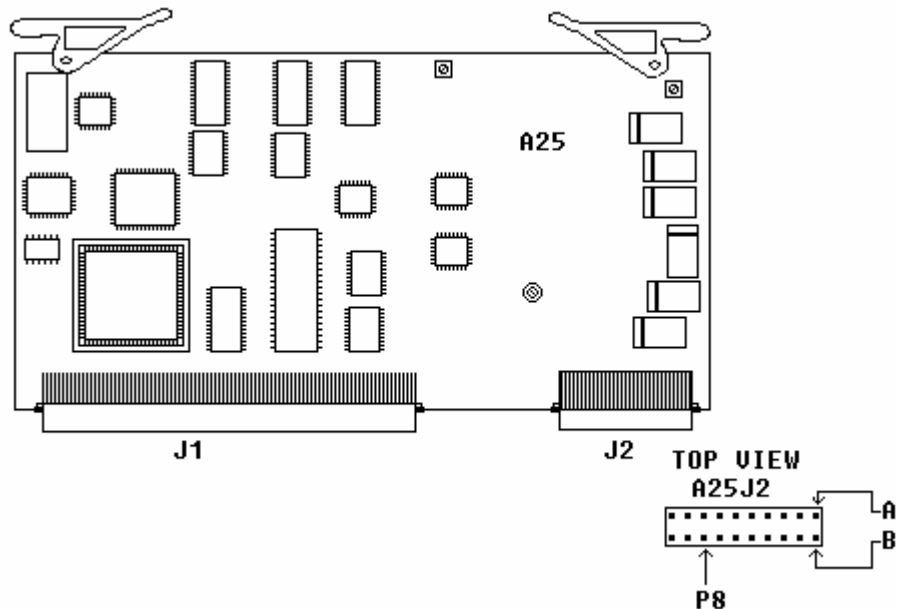

Figure 4. A25 digitizer module.

- (22) Adjust A4R5 (fig. 1) to position signal on -40 dBm line (1st major division from the top) (R).
- (23) Press **DATA SCROLL** arrow key to select **1 kHz** scan width and press **DATA ENTRY ENTER** key.
- (24) Adjust A4R96 (fig. 1) for a -40 dBm display on TI (R).
- (25) Press **DATA SCROLL** arrow key to select **10 kHz** scan width and press **DATA ENTRY ENTER** key.
- (26) Adjust A4R57 (fig. 1) for a -40 dBm display on TI (R).
- (27) Press **DATA SCROLL** arrow key to select **1 MHz** scan width and press **DATA ENTRY ENTER** key.

- (28) Adjust A4R24 (fig. 1) for a -40 dBm display on TI (R).
- (29) Press **Freq (F1)** (Frequency Display) key and **DATA ENTRY . 2 5 M** keys (.25 MHz).
- (30) Press **Atten (F4)** (Attenuation Display) key and press **DATA SCROLL** arrow key to select **0 dB**.
- (31) Press **Scan (F3)** (Scan Width) and **DATA SCROLL** arrow keys to select **1 MHz**.

NOTE

A12R2 and A12R3 (fig. 5) are interactive and adjustment will be extremely sensitive.

- (32) Alternately adjust A12R2 and A12R3 (fig. 5) on receiver IF module for minimum amplitude of the 1st LO signal -50 dBm maximum (R).

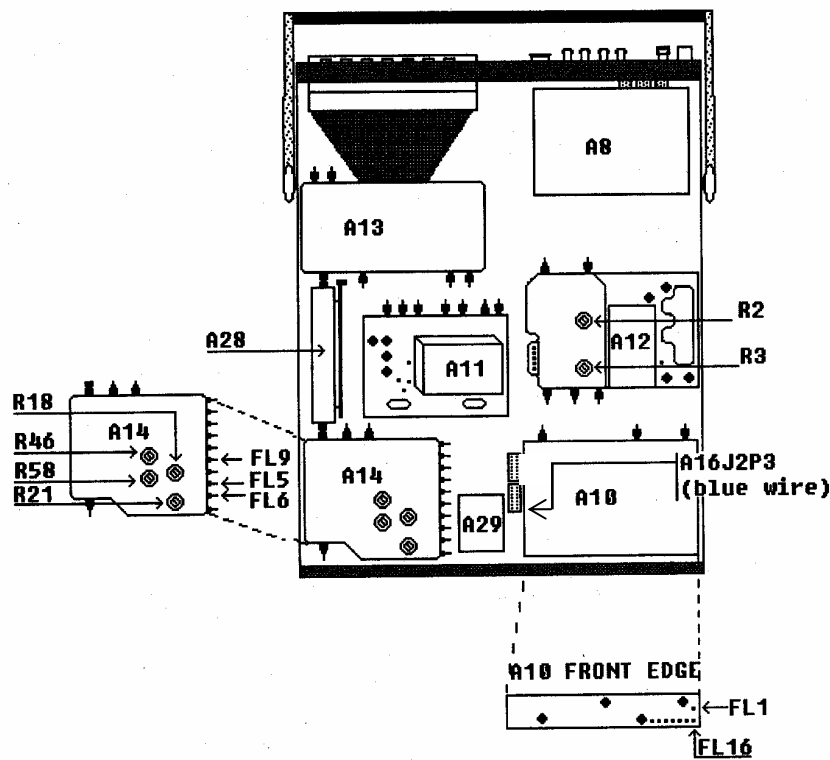

Figure 5. Test instrument - bottom view.

- (33) Press **TI POWER** key off. Remove digitizer module from extender card, remove extender card, and reinstall digitizer module in TI. Press **TI POWER** key ON.

19. Power Meter Calibration

a. Performance Check

(1) Press key sequence listed in (a) through (f) below:

- (a) **MODE MTRS** Meters Menu
- (b) **AUX (F6)** Auxiliary Function Menu
- (c) **MEMORY RCL** Recall
- (d) **FIELD SELECT ↑** Highlight **10. Factory Defaults**
- (e) **DATA ENTRY ENTER** Factory Defaults recall

NOTE

Assure highlighted area indicates **YES** before proceeding.

- (f) **DATA ENTRY ENTER** Factory Defaults restored

(2) Press **MODE MTRS** (Meters Menu) key and **DATA ENTRY 3** key (Pwr Meter (Pulse/CW)).

(3) Connect equipment as shown in figure 6.

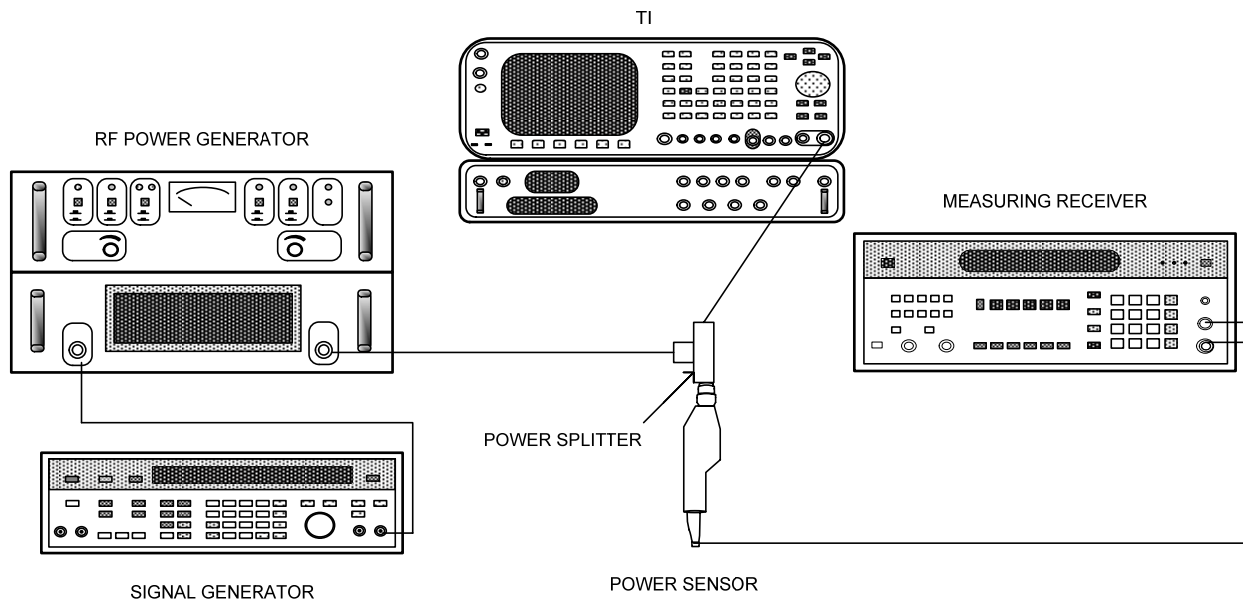

Figure 6. Power meter setup (20mW – 500mW range).

(4) Press **Range (F1)** and **DATA SCROLL** arrow keys to select **20 mW** range and press **Zero (F4)** key. Press **DATA ENTRY ENTER** key when **Zero** submenu appears.

NOTE

Do not exceed RF Generator Maximum Input (1V)

(5) Adjust signal generator frequency to 10 MHz and output to 10 mV. Adjust RF power amplifier gain to minimum then adjust gain and signal generator output for measuring receiver indication listed in table 14 corresponding to 20 mW range.

Table 14. Power Meter Accuracy 10/400 MHz

Test instrument RANGE	Source output	Measuring receiver indications	RF Power wattmeter indications	Test instrument indications	
				Min	Max
20 mW	10.00 mW	10.00 mW	-----	8.9 mW	11.1 mW
50 mW	25.00 mW	25.00 mW	-----	22.4 mW	27.6 mW
100 mW	50.00 mW	50.00 mW	-----	44 mW	56 mW
200 mW	100.0 mW	100.0 mW	-----	89 mW	111 mW
500 mW	250.0 mW	250.0 mW	-----	224 mW	276 mW
1 W	0.5 W	-----	500.0 mW	0.44 W	0.56 W
2 W	1.0 W	-----	1.0 W	0.89 W	1.11 W
5 W	4.0 W	-----	4.0 W	3.59 W	4.41 W
10 W	5.0 W	-----	5.0 W	4.4 W	5.6 W
20 W	10.0 W	-----	10.0 W	8.9 W	11.1 W
50 W	25.0 W	-----	25.0 W	22.4 W	27.6 W
100 W	50.0 W	-----	50.0 W	44 W	56 W
200 W	50.0 W	-----	50.0 W	44 W	56 W

- (6) Set measuring receiver to measure RF power at 10 MHz.
- (7) If TI does not indicate within limits specified in table 14, perform **b** below.
- (8) Repeat (5) above for the 50, 100, 200 and 500 mW ranges listed in table 14.
- (9) Repeat (5) and (8) above for a frequency of 400 MHz. If TI does not indicate within limits specified in table 14 perform **b** below.
- (10) Repeat (5) and (8) above for a frequency of 750 MHz using table 15.

Table 15. Power Meter Accuracy 750 MHz

Test instrument RANGE	Source output	Measuring receiver indications	RF Power wattmeter indications	Test instrument indications	
				Min	Max
20 mW	10.00 mW	10.00 mW	-----	7.9 mW	12.1 mW
50 mW	25.00 mW	25.00 mW	-----	19.9 mW	30.1 mW
100 mW	50.00 mW	50.00 mW	-----	39 mW	61 mW
200 mW	100.0 mW	100.0 mW	-----	79 mW	121 mW
500 mW	250.0 mW	250.0 mW	-----	199 mW	301 W
1 W	0.5 W	-----	500.0 mW	0.39 W	0.61 W
2 W	1.0 W	-----	1.0 W	0.79 W	1.21 W
5 W	4.0 W	-----	4.0 W	3.19 W	4.81 W
10 W	5.0 W	-----	5.0 W	3.9 W	6.1 W
20 W	10.0 W	-----	10.0 W	7.9 W	12.1 W
50 W	25.0 W	-----	25.0 W	19.9 W	30.1 W
100 W	50.0 W	-----	50.0 W	39 W	61 W
200 W	50.0 W	-----	50.0 W	39 W	61 W

(11) Reduce signal generator and RF power amplifier outputs to minimum and disconnect equipment setup.

(12) Connect equipment as shown in figure 7.

NOTE

Use directional power sensor model 4021.

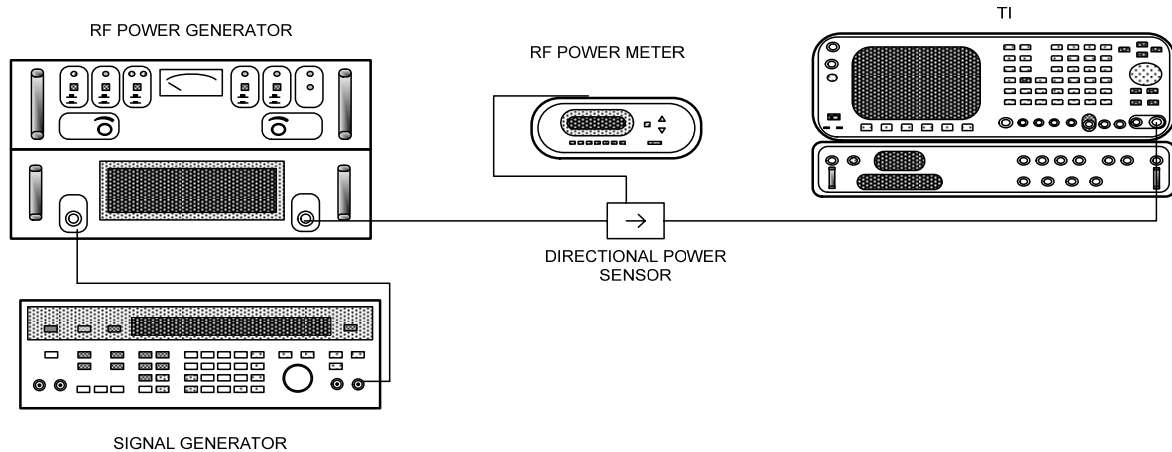

Figure 7. Power meter setup (1W - 200W range).

(13) Press **Range (F1)** and **DATA SCROLL** arrow keys to select **20 mW** range and press **Zero (F4)** key. Press **DATA ENTRY ENTER** key when **Zero** submenu appears. Adjust **DATA SCROLL** knob to select **1 W** range and press the **DATA ENTRY ENTER** key.

(14) Adjust signal generator frequency to 10 MHz and output to 100 mV. Adjust RF power amplifier gain to minimum then adjust gain and signal generator output for measuring receiver indication listed in table 14 corresponding to 1W range.

(15) If the TI does not indicate within minimum maximum limits listed in table 14 for range being checked, perform **b** below.

(16) Repeat (14) for 2, 5, 10, 20, 50, 100, and 200 W ranges listed in table 14.

(17) Reduce signal generator and RF power amplifier outputs to minimum and replace directional power sensor model 4021 with model 4022. Repeat (14) and (16) above for a frequency of 400 MHz.

(18) Repeat (14) and (16) above for a frequency of 750 MHz using table 15 instead of table 14.

(19) If the TI does not indicate within limits specified in table 15 perform **b** below.

b. Adjustments

(1) Press key sequence listed in (a) through (f) below:

- (a) **MODE MTRS** Meters Menu
- (b) **AUX (F6)** Auxiliary Function Menu
- (c) **MEMORY RCL** Recall
- (d) **FIELD SELECT ↑** Highlight **10. Factory Defaults**
- (e) **DATA ENTRY ENTER** Factory Defaults recall

NOTE

Assure highlighted area indicates **YES** before proceeding.

- (f) **DATA ENTRY ENTER** Factory Defaults restored

(2) Press **MODE RF GEN** (MODE RF GEN display), **Level (F3)** (Level display), **DATA ENTRY ± 1 2 7** and **ENTER** keys (-127 dB).

(3) Press key sequence listed in (a) through (f) below:

- (a) **MODE RCVR** Receiver Display
- (b) **SETUP** Rcvr Menu
- (c) **DATA ENTRY 1** Set Rcvr Freq
- (d) **DATA ENTRY 1 0 0 M** 100 MHz
- (e) **DATA ENTRY 3** Select Rcvr In T/R
- (f) **RET (F5)** Return

(4) Stand TI on end and locate power term, A14 (fig. 5) in lower left hand corner.

(5) Press **MODE MTRS** (Meters Menu) key and **DATA ENTRY 3** key (Pwr Meter (Pulse/CW)).

(6) Press **Range (F1)** and **DATA SCROLL** arrow keys to select **2 W** range, then press **DATA ENTRY ENTER** key.

(7) Connect a 50 Ω load to TI **T/R**.

(8) Connect multimeter to A14FL9 (fig. 5) RF power level output, and set multimeter to measure V dc.

(9) Adjust A14R21 (fig. 5) for a multimeter indication of 20 mV dc ±2 mV (R).

(10) Press **Range (F1)** key, press **DATA SCROLL** arrow keys to select **200 W** range. Press **DATA ENTRY ENTER** key.

(11) Adjust A14R18 (fig. 5) for a multimeter indication of 10 mV dc ±2 mV (R).

(12) Press **Range (F1)** and **DATA SCROLL** arrow keys to select **2 W** range, and press **DATA ENTRY ENTER** key.

(13) Remove the 50 Ω load from TI **T/R**.

(14) Connect measuring receiver sensor module to RF power amplifier **OUTPUT** using 10 dB attenuator (fixed).

(15) Adjust signal generator frequency to 85 MHz and output to 10mV. Adjust RF power amplifier gain to minimum then adjust gain and signal generator output until measuring receiver indicates exactly 33 dB (2 W) minus 10 dB attenuator (fixed) insertion loss.

(16) Disconnect RF power amplifier from 10 dB attenuator (fixed) and measuring receiver and connect RF power amplifier to TI **T/R**. Adjust A14R58 (fig. 5) for 4.02 V dc ± 100 mV (R).

(17) Disconnect equipment setup. Connect a 50 Ω load to TI **T/R**. If multimeter does not indicate 20 mV dc ± 2 mV, readjust A14R21 (fig. 5).

(18) Connect equipment as shown in figure 7.

NOTE

Use directional power sensor model 4022.

(19) Press **Range (F1)** and **DATA SCROLL** arrow keys to select **200 W** range and press **DATA ENTRY ENTER** key.

(20) Adjust signal generator frequency to 200MHz. Adjust signal generator and RF power amplifier output to 50W.

(21) Adjust A14R46 (fig. 5) for 1.97 V dc ± 100 mV (R).

(22) Disconnect equipment setup. Connect a 50 Ω load to TI **T/R**. If multimeter does not indicate 10 mV dc ± 2 mV, readjusting A14R18 (fig. 5), after allowing 2 minutes cooling minimum.

(23) Press key sequence listed in (a) through (e) below:

- (a) **MODE MTRS** Meters Menu
- (b) **AUX (F6)** Auxiliary Functions Menu
- (c) **DATA ENTRY 1** Calibrations
- (d) **DATA ENTRY 1** Power Meter
- (e) **Range (F1)** several times until PWR C indicates a 20 mW range

(24) Press **Zero (F2)** key and verify **POWER METER ZERO** window is momentarily displayed. Should read approximately 270.

(25) Press **Range (F1)** several times until **PWR C** indicates a **20 W** range.

(26) Press **Zero (F2)** key and verify **POWER METER ZERO** window is momentarily displayed. Should read approximately 130.

(27) Connect measuring receiver sensor module to RF power amplifier **OUTPUT** using 10 dB attenuator (fixed).

(28) Adjust signal generator frequency to 85 MHz. Adjust signal generator and RF power amplifier output until measuring receiver indicates exactly 33 dB minus 10 dB attenuator (fixed) test report value.

(29) Disconnect RF power amplifier and 10 dB attenuator (fixed) from measuring receiver. Connect RF power amplifier **OUTPUT** to TI **T/R** using 10 dB attenuator (fixed).

(30) Press **Range (F1)** key repeatedly to select **2 W** range, and press **DATA ENTRY ENTER** key.

(31) Press key sequence listed in (a) through (e) below:

- (a) **AUX (F6)** Auxiliary Function Menu
- (b) **DATA ENTRY 1** Calibration Menu
- (c) **DATA ENTRY 1** Power Meter
- (d) **DATA ENTRY ENTER** Power entry mode
- (e) **DATA ENTRY 2 ENTER** 2 W

(32) Press **Range (F1)** (power meter range mode) repeatedly to select **200 W** range and press **DATA ENTRY ENTER** (200 W range) key.

(33) Connect equipment as shown in figure 7.

(34) Adjust signal generator frequency to 200 MHz. Adjust signal generator and RF power amplifier output to 50W.

(35) Press key sequence listed in (a) through (f) below:

- (a) **AUX (F6)** Auxiliary Functions Menu
- (b) **DATA ENTRY 1** Calibrations
- (c) **DATA ENTRY 1** Power Meter
- (d) **DATA ENTRY ENTER** ENTER
- (e) **DATA ENTRY 5 0 ENTER**.... 50 W
- (f) **Ret (F5)** Return

(36) Press **MODE RF GEN** (MODE RF GEN Display); when prompted for backup data, press **SHIFT** and **Y** keys (Backup Cal Data ? y/n).

(37) Disconnect all test equipment.

20. Generator Amplitude Modulation

a. Performance Check

(1) Press key sequence listed in (a) through (f) below:

- (a) **MODE MTRS** Meters Menu
- (b) **AUX (F6)** Auxiliary
- (c) **MEMORY RCL** Recall
- (d) **FIELD SELECT ↑**..... Highlight **10. Factory Defaults**

- (e) **DATA ENTRY ENTER** Factory Defaults recall

NOTE

Assure highlighted area indicates **YES** before proceeding.

- (f) **DATA ENTRY ENTER** Factory Defaults restored

(2) Connect measuring receiver sensor module to TI **T/R**. Connect measuring receiver **MODULATION OUTPUT/AUDIO INPUT** to audio analyzer **INPUT HIGH**.

(3) Set measuring receiver to measure AM, low pass filter 3 kHz, high pass filter 50 Hz, and **PEAK ±/2** detector selected.

(4) Press key sequence listed in (a) through (h) below:

- (a) **MODE RF GEN** RF Gen Display
- (b) **SETUP** Gen Menu
- (c) **DATA ENTRY 5** RF Gen Setup
- (d) **DATA ENTRY 1** RF Gen Freq
- (e) **DATA ENTRY 7 5 0 K** 750 kHz
- (f) **DATA ENTRY 2** RF Gen Level
- (g) **DATA ENTRY 0 ENTER** 0 dBm
- (h) **Ret (F5)** Return

(5) Record measuring receiver indication as residual AM.

(6) Repeat (4) (e) and (5) above for RF generator frequencies of 10 and 900 MHz.

(7) Press **DATA ENTRY 1 2 1 . 1 M** keys (121.1 MHz).

(8) Press **Source (F4)** (Audio Frequency Source), **DATA ENTRY 1**, and **DATA ENTRY ENTER** keys to set source to 1 and AM.

(9) Set measuring receiver to measure AM, low pass filter 3 kHz, high pass filter 50 Hz and **PEAK ±/2** detector selected. Set audio analyzer to measure distortion in percent.

(10) Press **More (F6)**, **A Freq (F1)** and press **DATA ENTRY** keys to set **AF FREQ** to **100 Hz**, then press **DATA ENTRY ENTER** key.

(11) Press **More (F6)** key twice, **Mod (F5)** and **DATA ENTRY** keys to set **MODULATION** to **50%**, then press **DATA ENTRY ENTER** keys.

(12) Audio analyzer indication will be less than specified in table 16 for current TI setting.

(13) Repeat (7) and (9) through (12) for remaining settings listed in table 16.

NOTE

Pressing **More (F6)** will scroll various options on the bottom of the display. The options will change the functions assigned to the **F1** through **F6** function keys. This may be necessary to obtain the **Freq (F2)**, **Mod (F5)**, and **A Freq (F1)** options required in the following tests.

(14) Set measuring receiver to measure AM, with low pass filter of 15 kHz, high pass filter of 50 Hz, and PEAK±/2 detector selected.

Table 16. Amplitude Modulation Distortion

Test instrument		Measuring receiver		Audio analyzer
RF frequency	Modulation rate	Low pass	High pass	Distortion (%)
121.1 MHz	100 Hz	3 kHz	50 Hz	<1.5
121.1 MHz	1 kHz	3 kHz	300 Hz	<0.7
121.1 MHz	6 kHz	15 kHz	300 Hz	<1.5
121.1 MHz	7 kHz	15 kHz	300 Hz	<2.5
121.1 MHz	10 kHz	15 kHz	300 Hz	<2.5
900 kHz	1 kHz	3 kHz	300 Hz	<5.0
900 kHz	100 Hz	3 kHz	50 Hz	<5.0
900 kHz	10 kHz	15 kHz	300 Hz	<5.0

(15) Press **Freq (F2)** (Frequency Display Mode) and press **DATA ENTRY** keys to set frequency to **750 kHz**.

(16) Press **A Freq (F1)** (AF Frequency Mode) and press **DATA ENTRY** keys to set **AF FREQ** to **100 Hz**. Press **DATA ENTRY ENTER** keys.

(17) Press **Mod (F5)** (% Modulation Mode) and press **DATA ENTRY** keys to set **MODULATION** to **30%**. Press **DATA ENTRY ENTER** keys.

(18) If measurement receiver indication minus residual AM recorded in (5) above is not within limits specified in table 17 for appropriate TI setting, perform **b** below.

(19) Repeat steps (15) through (18) for remaining settings listed in table 17.

Table 17. Amplitude Modulation Accuracy

Test instrument			Measuring receiver ¹ indications	
RF frequency	Modulation rate	Percent modulation	Min	Max
750 kHz	100 Hz	30%	27.00	33.00
750 kHz	100 Hz	60%	54.0	66.0
750 kHz	100 Hz	90%	81.0	99.0
750 kHz	1 kHz	90%	81.0	99.0
750 kHz	1 kHz	60%	54.0	66.0
750 kHz	1 kHz	30%	27.00	33.00
750 kHz	10 kHz	30%	27.00	33.00
750 kHz	10 kHz	60%	54.0	66.0
750 kHz	10 kHz	90%	81.0	99.0
10 MHz	100 Hz	90%	85.5	94.5
10 MHz	100 Hz	60%	57.0	63.0
10 MHz	100 Hz	30%	28.50	31.50
10 MHz	1 kHz	30%	28.50	31.50
10 MHz	1 kHz	60%	57.0	63.0
10 MHz	1 kHz	90%	85.5	94.5

See footnote at end of table.

Table 17. Amplitude Modulation Accuracy - Continued

Test instrument			Measuring receiver ¹ indications	
RF frequency	Modulation rate	Percent modulation	Min	Max
10 MHz	10 kHz	90%	85.5	94.5
10 MHz	10 kHz	60%	57.0	63.0
10 MHz	10 kHz	30%	28.50	31.50
900 MHz	100 Hz	30%	28.50	31.50
900 MHz	100 Hz	60%	57.0	63.0
900 MHz	100 Hz	90%	85.5	94.5
900 MHz	1 kHz	90%	85.5	94.5
900 MHz	1 kHz	60%	57.0	63.0
900 MHz	1 kHz	30%	28.50	31.50
900 MHz	10 kHz	30%	28.50	31.50
900 MHz	10 kHz	60%	57.0	63.0
900 MHz	10 kHz	90%	85.5	94.5

¹Set measuring receiver filters as needed.

b. Adjustments

(1) Press key sequence listed in (a) through (f) below:

- (a) **MODE MTRS** Meters Menu
- (b) **AUX (F6)** Auxiliary
- (c) **MEMORY RCL** Recall
- (d) **FIELD SELECT ↑** Highlight **10. Factory Defaults**
- (e) **DATA ENTRY ENTER** Factory Defaults recall

NOTE

Assure highlighted area indicates **YES** before proceeding.

- (f) **DATA ENTRY ENTER** Factory Defaults restored

(2) Position measuring receiver controls to measure AM, with low pass filter of 3 kHz and PEAK±/2 detector selected.

(3) Press key sequence listed in (a) through (h) below:

- (a) **MODE RF GEN** RF Gen Display
- (b) **SETUP** Gen Menu
- (c) **DATA ENTRY 5** RF Gen Setup
- (d) **DATA ENTRY 1** RF Gen Freq
- (e) **DATA ENTRY 1 2 1 . 1 M** 121.1 MHz
- (f) **DATA ENTRY 2** RF Gen Level
- (g) **DATA ENTRY 0 ENTER** 0 dBm
- (h) **Ret (F5)** Return

- (4) Press **MODE MTRS** (Meter Menu), **AUX (F6)** (Auxiliary Functions Menu), and **DATA ENTRY 1** keys (calibrations).
- (5) Press **FIELD SELECT** arrow keys until **13. Gen Modulation** is highlighted, and press **DATA ENTRY ENTER** key.
- (6) Press **DATA ENTRY 1** (AM Modulation (90%)) **1 8 0** and **ENTER** keys (correction factor of 180).
- (7) Adjust A9 AM MOD ADJ (fig. 1) on 90 MHz board assembly to set modulation reading on measuring receiver to 90% ±4.5% (R).
- (8) Press **ESC (F6)** (Escape), **MODE RF GEN** (MODE RF GEN Display), **DATA ENTRY SHIFT**, and **Y** keys (Backup Cal Data ? y/n).
- (9) Press **Source (F4)** (Modulation Source), and **DATA SCROLL** arrow keys to select **SOURCE 1 MOD AM**, and press **DATA ENTRY ENTER** key (selects AM modulation).
- (10) Press **Mod (F5)** (Modulation Mode), **DATA ENTRY 9 0** and **ENTER** keys (90% AM).
- (11) Press **A Freq (F1)** (Audio Frequency Mode), **DATA ENTRY 1 0 0** and **ENTER** keys (100 Hz modulation frequency).
- (12) Verify that the measuring receiver indicates 90% AM ±4.5%.
- (13) Press **A Freq (F1)** (Audio Frequency mode), **ENTER** keys (10 kHz modulation frequency).
- (14) Set measuring receiver low pass filter to 15 kHz and verify measuring receiver indicates 90% AM ± 4.5%.

21. Generator Frequency Modulation

NOTE

All references to low pass filter settings of >20 kHz pertain to measurement at 900 MHz only for the rest of this paragraph.

a. Performance Check

- (1) Press key sequence listed in (a) through (f) below:
 - (a) **MODE MTRS** Meters Menu
 - (b) **AUX (F6)** Auxiliary
 - (c) **MEMORY RCL** Recall
 - (d) **FIELD SELECT ↑** Highlight **10. Factory Defaults**
 - (e) **DATA ENTRY ENTER** Factory Defaults recall

NOTE

Assure highlighted area indicates **YES** before proceeding.

- (f) **DATA ENTRY ENTER** Factory Defaults

(2) Connect measuring receiver sensor module to TI **T/R**. Connect measuring receiver **MODULATION OUTPUT/AUDIO INPUT** to audio analyzer **INPUT HIGH**.

(3) Set measuring receiver to measure FM, low pass filter 15 kHz, high pass filter 50 Hz, and **PEAK±/2** detector selected.

(4) Press key sequence listed in (a) through (h) below:

- (a) **MODE RF GEN** RF Gen Display
- (b) **SETUP** Gen Menu
- (c) **DATA ENTRY 5** RF Gen Setup
- (d) **DATA ENTRY 1** RF Gen Freq
- (e) **DATA ENTRY 7 5 0 K** 750 kHz
- (f) **DATA ENTRY 2** RF Gen Level
- (g) **DATA ENTRY 0 ENTER** 0 dBm
- (h) **Ret (F5)** Return

(5) Record measuring receiver indication as residual FM in table 18. Repeat this step for remaining measuring receiver low pass filter settings listed in table 18 for TI RF frequency 750 kHz.

Table 18. Data Calculations Table

TI RF frequency	Measuring receiver	
	Low pass filter settings	Residual FM indications
750 kHz	15 kHz	
750 kHz	3 kHz	
900 MHz	3 kHz	
900 MHz	>20 kHz	

(6) Repeat (4) (e) and (5) above for **MODE RF GEN** frequency of 900 MHz.

(7) Press **(F4) SOURCE** (Modulation Source) key. Press **DATA SCROLL** arrow keys until **SOURCE 1 MOD FM** is displayed and press **DATA ENTRY ENTER** key.

NOTE

Pressing **More (F6)** will scroll various options on the bottom of the display. The options will change the functions assigned to the **F1** through **F6** function keys. This may be necessary to obtain the **Freq (F2)**, **Mod (F5)**, and **A Freq (F1)** options required in the following tests.

(8) Set measuring receiver to select **PEAK±/2** detector, low pass filter to 3 kHz and high pass filter to 300 Hz. Set audio analyzer to measure distortion in percent.

(9) Press **Freq (F2)** (RF Frequency Mode) and press **DATA ENTRY** keys to set frequency to **750 kHz**.

(10) Press **Dev (F5)** (Deviation Mode) and press **DATA ENTRY** keys to set **DEVIATION** to **10 kHz**, the **FIELD SELECT** arrow keys to **AF FREQ**, and **DATA ENTRY** keys to set **AF FREQ** to **1 kHz**.

(11) Audio analyzer indication will be less than specified in table 19 for current TI setting.

(12) Repeat (10) and (11) for remaining settings listed in table 19.

(13) Repeat (9) through (12) for a RF frequency mode setting of 900 MHz.

Table 19. Frequency Modulation Distortion

Test instrument		Measuring receiver		Audio analyzer distortion (%)
Modulation rate	Deviation setting	Low pass	High pass	
1 kHz	10 kHz	3 kHz	300 Hz	<.70
30 Hz	10 kHz	3 kHz	<20 Hz	<1.0
10 kHz	10 kHz	15 kHz	300 Hz	<1.0
11 kHz	10 kHz	15 kHz	300 Hz	<2.0

(14) Set measuring receiver low pass filter to 3 kHz, high pass filter to <20 Hz and select **PEAK±/2** detector.

(15) Press **Freq (F2)** (RF Frequency Mode) and press **DATA ENTRY** keys to set frequency to **750 kHz**.

(16) Press **A Freq (F1)** (Audio Frequency Mode) and press **DATA ENTRY** keys to set **AF FREQ** to **30 Hz**. Press **DATA ENTRY ENTER** key.

(17) Press **Dev (F5)** (Deviation Mode) and press **DATA ENTRY** keys to set **DEVIATION** to **.100 kHz**.

NOTE

If widely fluctuating readings are observed, use slow peak detector mode and de-emphasis filters of measuring receiver as required.

(18) If measuring receiver indication, minus residual FM recorded in (5) above, is not within limits specified in table 20 for appropriate TI setting, perform **b** below.

(19) Repeat (14) through (18) for remaining settings listed in table 20.

Table 20. Frequency Modulation Accuracy

Test instrument			Measuring receiver ¹ indications	
RF frequency	Modulation rate	Deviation modulation	Min	Max
750 kHz	30 Hz	100 Hz	.090	.110
750 kHz	30 Hz	10 kHz	9.50	10.50
750 kHz	30 Hz	25 kHz	22.50	27.50
750 kHz	1 kHz	100 Hz	.090	.110

See footnote at end of table.

Table 20. Frequency Modulation Accuracy - Continued

Test instrument			Measuring receiver ¹ indications	
RF frequency	Modulation rate	Deviation modulation	Min	Max
750 kHz	1 kHz	10 kHz	9.50	10.50
750 kHz	1 kHz	25 kHz	22.50	27.50
750 kHz	10 kHz	10 kHz	9.50	10.50
750 kHz	10 kHz	25 kHz	22.50	27.50
900 MHz	30 Hz	100 Hz	.090	.110
900 MHz	30 Hz	10 kHz	9.50	10.50
900 MHz	30 Hz	25 kHz	22.50	27.50
900 MHz	1 kHz	100 Hz	.090	.110
900 MHz	1 kHz	10 kHz	9.50	10.50
900 MHz	1 kHz	25 kHz	22.50	27.50
900 MHz	20 kHz	10 kHz	9.50	10.50
900 MHz	20 kHz	25 kHz	22.50	27.50

¹Set measuring receiver filters as needed.

b. Adjustments

(1) Press key sequence listed in (a) through (f) below:

- (a) **MODE MTRS** Meters Menu
- (b) **AUX (F6)** Auxiliary
- (c) **MEMORY RCL** Recall
- (d) **FIELD SELECT ↑** Highlight **10. Factory Defaults**
- (e) **DATA ENTRY ENTER** Factory Defaults recall

NOTE

Assure highlighted area indicates **YES** before proceeding.

(f) **DATA ENTRY ENTER** Factory Defaults restored

(2) Connect measuring receiver power sensor module to TI **T/R**.

(3) Set measuring receiver to measure FM, with low pass filter of 15 kHz, high pass filter of 300 Hz, and **PEAK±/2** detector selected.

(4) Press key sequence listed in (a) through (k) below

- (a) **MODE MTRS** Meter Menu
- (b) **AUX (F6)** Auxiliary Functions Menu
- (c) **DATA ENTRY 1** Calibrations
- (d) **FIELD SELECT** arrow Highlight **13. Gen Modulation**
- (e) **DATA ENTRY ENTER** Select **13. Gen Modulation**
- (f) **DATA ENTRY 2** FM Deviation (20 kHz)
- (g) **DATA ENTRY 2, 0, 0, ENTER** Correction Factor of 200

- (h) **DATA ENTRY ENTER** Sets Correction Factor
 - (i) **ESC (F6)** Escape
 - (j) **MODE RF GEN** RF Gen Display
 - (k) **DATA ENTRY SHIFT, Y** (Backup Cal Data ? y/n)
- (5) Press key sequence listed in (a) through (q) below:
- (a) **MODE RF GEN** RF Gen Display
 - (b) **SETUP** Gen Menu
 - (c) **DATA ENTRY 5** RF Gen Setup
 - (d) **DATA ENTRY 1** RF Gen Freq
 - (e) **DATA ENTRY 1 0 M** 10 MHz
 - (f) **DATA ENTRY 2** RF Gen Level
 - (g) **DATA ENTRY 0 ENTER** 0 dB level
 - (h) **ESC (F6)** Escape
 - (i) **DATA ENTRY 1** Func Gen No. 1 Setup
 - (j) **DATA ENTRY 1** Func Gen 1
 - (k) **DATA ENTRY 3** FM
 - (l) **DATA ENTRY 2** Freq
 - (m) **DATA ENTRY 2 2 6 4 . 5** 2264.5
 - (n) **DATA ENTRY ENTER** 2264.5 Hz
 - (o) **DATA ENTRY 4** FM Dev
 - (p) **DATA ENTRY 1 2 . 5 K** 12.5 kHz
 - (q) **Ret (F5)** Return

NOTE

Pressing **More (F6)** will scroll various options on the bottom of the display. The options will change the functions assigned to the **F1** through **F6** function keys. This may be necessary to obtain the **Disp (F1)**, **Freq (F2)**, **Mod (F5)**, and **A Freq (F1)** options required in the following tests.

- (6) Press **Disp (F1)** (Display Mode), and **DATA ENTRY 2** (Full Anlz Mode) keys.
- (7) Press **Scan (F5)** (Scan Width Mode) key and press **DATA SCROLL** arrow keys to select **1 kHz**, then press **DATA ENTRY ENTER** key (1 kHz scan width).
- (8) Adjust A9 FM MOD ADJ (fig. 1) on the 90 MHz GEN MECH ASSY until level of carrier frequency is nulled down to the noise floor on TI spectrum analyzer display.
- (9) Press **Freq (F1)** (RF Frequency Mode) key, and press **DATA SCROLL** arrow keys to set **RF** to **10.0001 MHz**. Press **DATA ENTRY ENTER** key.

(10) Adjust A9 FM MOD ADJ (fig. 1) on the 90 MHz GEN MECH ASSY until level of carrier frequency is nulled down to center horizontal graticule on TI spectrum analyzer display.

(11) Press **Freq (F1)** (RF Frequency Mode) key, and press **DATA SCROLL** arrow keys to set **RF** to **10.0000 MHz**. Press **DATA ENTRY ENTER** key.

(12) Adjust A9 FM MOD ADJ (fig. 1) on the 90 MHz GEN MECH ASSY until level of carrier frequency is about midway between the levels of the two final levels in (8) and (10) above on TI spectrum analyzer display.

(13) Repeat (9) through (12) above until the center frequency level does not vary by more than 2 dB.

(14) The measuring receiver FM display should indicate a value approximately balanced around 12.5 kHz and within ± 100 Hz when RF frequency is toggled between 10.0000 and 10.0001 MHz.

(15) Press key sequence listed in (a) through (k) below:

- (a) **MODE MTRS** Meter Menu
- (b) **AUX (F6)** Auxiliary Function Menu
- (c) **DATA ENTRY 1** Calibrations
- (d) **FIELD SELECT** arrow Highlight **13. Gen Modulation**
- (e) **DATA ENTRY ENTER** Select **13. Gen Modulation**
- (f) **DATA ENTRY 3** FM Deviation (80 kHz)
- (g) **DATA SCROLL** keys until measuring receiver indicates 80 kHz ± 4 kHz
- (h) **DATA ENTRY ENTER** Set Correction Factor
- (i) **ESC (F6)** Escape
- (j) **MODE RF GEN** RF Gen Display
- (k) **DATA ENTRY SHIFT Y** (Backup Cal Data? y/n)

22. FM Deviation Meter (Peak)

a. Performance Check

(1) Press key sequence listed in (a) through (f) below:

- (a) **MODE MTRS** Meters Menu
- (b) **AUX (F6)** Auxiliary
- (c) **MEMORY RCL** Recall
- (d) **FIELD SELECT** \uparrow Highlight **10. Factory Defaults**
- (e) **DATA ENTRY ENTER** Factory Defaults recall

NOTE

Assure highlighted area indicates **YES** before proceeding.

(f) **DATA ENTRY ENTER** Factory Defaults restored

(2) Set signal generator for a 121.1 MHz, 0 dB output and turn **RF OUTPUT** off. Connect signal generator **RF OUTPUT** to power splitter input and connect **10 Meg Out** (rear panel) to measuring receiver **10 MHz** (rear panel).

(3) Connect one power splitter output to **TI ANTENNA**, and the other power splitter output to measuring receiver sensor module.

(4) Set measuring receiver to measure FM with **PEAK±/2** detector selected.

NOTE

Pressing **More (F6)** will scroll various options on the bottom of the display. The options will change the functions assigned to the **F1** through **F6** function keys. This may be necessary to obtain the **Freq (F1)**, **Atten (F4)**, and **FM Z (F3)** options required in the following tests.

(5) Press key sequence listed in (a) through (o) below:

- (a) **MODE RCVR** Receiver Display
- (b) **SETUP** Rcvr Menu
- (c) **DATA ENTRY 1** Set Rcvr Freq
- (d) **DATA ENTRY 1 2 1 . 1 M** 121.1 MHz
- (e) **DATA ENTRY 4** Select Input Atten
- (f) **DATA ENTRY 3** 40 dB
- (g) **DATA ENTRY 2** Select Mode
- (h) **FIELD SELECT** arrow keys .. Highlight **11. User Defined**
- (i) **DATA ENTRY ENTER** Select **11. User Defined**
- (j) **DATA ENTRY 2** IF Filters
- (k) **DATA ENTRY 2** 30 kHz
- (l) **DATA ENTRY 3** Post Detection
- (m) **DATA ENTRY 2** Low Pass
- (n) **DATA ENTRY 1, K** 1 kHz
- (o) **Ret (F5)** Return

(6) Press **FIELD SELECT** arrow keys to highlight **DEV** function and press **DATA ENTRY ENTER** key.

(7) Press **DATA SCROLL** arrow keys to select **2 kHz (DEV range)** and press **DATA ENTRY ENTER** key. Set signal generator **RF OUTPUT** on.

(8) Press **Ret (F6)** and **FM Z (F3)** keys, and wait for zeroing process to complete. Record **TI +** and **-** residual FM.

(9) Set signal generator for 1 kHz FM deviation and a modulation rate of 100 Hz. Adjust the amount of deviation until measuring receiver indicates 1.000 kHz FM and press **FM Z (F3)**. Wait for zeroing process to complete.

(10) Algebraically subtract + residual FM recorded in (8) above from TI **DEV** indication and if result is not within limits specified in table 20, perform **b** below.

Table 20. FM Deviation Meter Accuracy (Peak)

Signal generator		Test instrument indications				
Mod rate	Deviation ¹	IF filter	LP filter	DEV range	Min (kHz)	Max (kHz)
100 Hz	1 kHz	30 kHz	1 kHz	2 kHz	0.73	1.27
100 Hz	30 kHz	30 kHz	1 kHz	50 kHz	25.9	34.1
2 kHz	30 kHz	300 kHz	9 kHz	50 kHz	26.8	33.2
2 kHz	1 kHz	300 kHz	9 kHz	2 kHz	0.76	1.24
5 kHz	1 kHz	300 kHz	15 kHz	2 kHz	0.76	1.24
5 kHz	90 kHz	300 kHz	15 kHz	100 kHz	84.4	95.6
14 kHz	90 kHz	300 kHz	30 kHz	100 kHz	84.4	95.6
14 kHz	45 kHz	300 kHz	30 kHz	50 kHz	41.2	48.8
14 kHz	10 kHz	300 kHz	30 kHz	20 kHz	9.4	10.6
14 kHz	5 kHz	300 kHz	30 kHz	10 kHz	4.6	5.4
14 kHz	2 kHz	300 kHz	30 kHz	5 kHz	1.72	2.28
14 kHz	1 kHz	300 kHz	30 kHz	2 kHz	0.76	1.24
16 kHz	1 kHz	300 kHz	30 kHz	2 kHz	0.73	1.27
16 kHz	90 kHz	300 kHz	30 kHz	100 kHz	81.7	98.3
19 kHz	90 kHz	300 kHz	30 kHz	100 kHz	81.7	98.3
19 kHz	1 kHz	300 kHz	30 kHz	2 kHz	0.73	1.27

¹Adjust measuring receiver high pass and low pass filters as required.

(11) Algebraically subtract - residual FM recorded in (8) above from TI **DEV** indication and if result is not within limits specified in table 20, perform **b** below.

(12) Set signal generator FM off and repeat technique of (5) through (11) above for remaining signal generator and TI settings in table 20.

b. Adjustments

- (1) Set signal generator **RF OUTPUT** off.
- (2) Press key sequence listed in (a) through (f) below:
 - (a) **MODE MTRS** Meters Menu
 - (b) **AUX (F6)** Auxiliary
 - (c) **MEMORY RCL** Recall
 - (d) **FIELD SELECT ↑** Highlight **10. Factory Defaults**
 - (e) **DATA ENTRY ENTER** Factory Defaults recall

NOTE

Assure highlighted area indicates **YES** before proceeding.

- (f) **DATA ENTRY ENTER** Factory Defaults restored

NOTE

Pressing **More (F6)** will scroll various options on the bottom of the display. The options will change the functions assigned to the **F1** through **F6** function keys. This may be necessary to obtain the **Freq (F1)**, **Atten (F4)**, and **FM Z (F3)** options required in the following tests.

(3) Adjust signal generator output for 121.1 MHz at 0 dBm with 9 kHz deviation at 3 kHz rate and turn the FM off.

(4) Set measuring receiver to measure FM, lowpass filter to >20 kHz, and select **PEAK±/2** detector.

(5) Press key sequence listed in (a) through (q) below:

- (a) **MODE RCVR** Receiver Display
- (b) **SETUP** Rcvr Menu
- (c) **DATA ENTRY 1** Set Rcvr Freq
- (d) **DATA ENTRY 1 2 1 . 1 M** 121.1 MHz
- (e) **DATA ENTRY 2** Select Mod
- (f) **DATA SCROLL** arrow keys ... Highlight **11. User Defined**
- (g) **DATA ENTRY ENTER** Select **11. User Defined**
- (h) **DATA ENTRY 2** IF Filters
- (i) **DATA ENTRY 3** 300 kHz
- (j) **DATA ENTRY 3** Post Detection
- (k) **DATA ENTRY 2** Low Pass Filter
- (l) **DATA ENTRY 2 5 K** 25 kHz
- (m) **ESC (F6)** Escape
- (n) **DATA ENTRY 4** Select Input Atten
- (o) **DATA ENTRY 3** 40 dB
- (p) Verify that selection **3. Select MODE RCVR In** indicates **Antenna** if not
press **DATA ENTRY 3** Antenna in
- (q) **Ret (F5)** Return

(6) Press key sequence listed in (a) through (g) below:

- (a) **DATA SCROLL** arrow keys ... Highlight **DEV**
- (b) **DATA ENTRY ENTER** Select **DEV**
- (c) **Range (F1)** Deviation Range
- (d) **DATA SCROLL** arrow keys ... Highlight **10 kHz** range
- (e) **DATA ENTRY ENTER** Select **10 kHz** deviation

- (f) **Ret (F6)** Return
 - (g) **FM Z (F3)** FM Zero
- (7) Set signal generator FM on.
- (8) Press **MODE MTRS** (Meters Menu), **AUX (F6)** (Auxiliary Functions Menu), and **DATA ENTRY ENTER** keys, then press **FIELD SELECT** arrow keys to highlight **2. Dev Meter (Peak)**. Press **DATA ENTRY ENTER** key.
- (9) Press **DATA ENTRY ENTER** and **DATA ENTRY** keys to enter value displayed on measuring receiver in 10 kHz(+) data field and press **DATA ENTRY ENTER** key.
- (10) Press **DATA ENTRY -** key, followed by **DATA ENTRY** numeric keys to enter value displayed on measuring receiver in 10 kHz(-) data field and press **DATA ENTRY ENTER** key.
- (11) Adjust signal generator output for 121.1 MHz at 0 dBm with 17 kHz deviation at 3 kHz rate. Set FM off.
- (12) Press **Ret (F5)** (Return), **MODE RCVR** (Receiver Display), **SHIFT**, and **Y** keys (Backup Cal Data ? y/n).
- (13) Press key sequence listed in (a) through (g) below:
- (a) **DATA SCROLL** arrow keys ... Highlight **DEV**
 - (b) **DATA ENTRY ENTER** Select **DEV**
 - (c) **Range (F1)** Deviation Range
 - (d) **DATA SCROLL** arrow keys ... Highlight **20 kHz** range
 - (e) **DATA ENTRY ENTER** Select 20 kHz Deviation
 - (f) **Ret (F6)** Return
 - (g) **FM Z (F3)** FM Zero
- (14) Set signal generator FM on.
- (15) Press **MODE MTRS** (Meters Menu), **AUX (F6)** (Auxiliary Functions Menu), and **DATA ENTRY ENTER** keys; press **FIELD SELECT** arrow keys to highlight **2. Dev Meter (Peak)** and press **DATA ENTRY ENTER** key.
- (16) Press **DATA ENTRY ENTER** and **DATA ENTRY** keys to enter value displayed on measuring receiver in 20 kHz(+) data field, and press **DATA ENTRY ENTER** key.
- (17) Press **DATA ENTRY -** key, followed by **DATA ENTRY** numeric keys to enter value displayed on measuring receiver in the 20 kHz(-) data field, and press **DATA ENTRY ENTER** key.
- (18) Press **Ret (F5)** (Return), **MODE RCVR** (Receiver Display), **SHIFT**, and **Y** keys (Backup Cal Data ? y/n).

(19) Adjust signal generator output for 121.1 MHz at 0 dBm with 45 kHz deviation at 3 kHz rate and set FM off.

(20) Press key sequence listed in (a) through (g) below:

- (a) **DATA SCROLL** arrow keys ... Highlight **DEV**
- (b) **DATA ENTRY ENTER** Select **DEV**
- (c) **Range (F1)** Deviation Range
- (d) **DATA SCROLL** arrow keys ... Hightlight **50 kHz** range
- (e) **DATA ENTRY ENTER** Select 50 kHz Deviation
- (f) **Ret (F6)** Return
- (g) **FM Z (F3)** FM Zero

(21) Set signal generator FM on.

(22) Press **MODE MTRS** (Meters Menu), **AUX (F6)** (Auxiliary Functions Menu), and **DATA ENTRY ENTER** keys; press **FIELD SELECT** arrow keys to highlight **2. Dev Meter (Peak)** and press **DATA ENTRY ENTER** key.

(23) Press **DATA ENTRY ENTER** key and press **DATA ENTRY** keys to enter value displayed on measuring receiver in 50 kHz(+) data field. Press **DATA ENTRY ENTER** key.

(24) Press **DATA ENTRY -** key, followed by **DATA ENTRY** numeric keys to enter value displayed on measuring receiver in 50 kHz(-) data field, and press **DATA ENTRY ENTER** key.

(25) Adjust signal generator output for 121.1 MHz at 0 dBm with 75 kHz deviation at 3 kHz rate and set FM off.

(26) Press **Ret (F5)** (Return), **MODE RCVR** (Receiver Display), **SHIFT**, and **Y** keys (Backup Cal Data ? y/n).

(27) Press key sequence listed in (a) through (g) below:

- (a) **DATA SCROLL** arrow keys ... Highlight **DEV**
- (b) **DATA ENTRY ENTER** Select **DEV**
- (c) **Range (F1)** Deviation Range
- (d) **DATA SCROLL** arrow keys ... Hightlight **100 kHz** range
- (e) **DATA ENTRY ENTER** 100 kHz deviation
- (f) **Ret (F6)** Return
- (g) **FM Z (F3)** FM Zero

(28) Set signal generator FM on.

(29) Press **MODE MTRS** (Meters Menu), **AUX (F6)** (Auxiliary Functions Menu), and **DATA ENTRY ENTER** keys; press **FIELD SELECT** arrow keys to highlight **2. Dev Meter (Peak)** and press **DATA ENTRY ENTER** key.

(30) Press **DATA ENTRY ENTER** and **DATA ENTRY** keys to enter value displayed on measuring receiver in 100 kHz(+) data field. Press **DATA ENTRY ENTER** key.

(31) Press **DATA ENTRY -** key, followed by **DATA ENTRY** numeric keys to enter value displayed on measuring receiver in 100 kHz(-) data field, and press **DATA ENTRY ENTER** key.

(32) Press **Ret (F5)** (Return), **MODE RCVR** (Receiver Display), **SHIFT**, and **Y** keys (Backup Cal Data ? y/n).

23. Amplitude Modulation Meter

a. Performance Check

(1) Press key sequence listed in (a) through (f) below:

- (a) **MODE MTRS** Meters Menu
- (b) **AUX (F6)** Auxiliary
- (c) **MEMORY RCL** Recall
- (d) **FIELD SELECT ↑** Highlight **10. Factory Defaults**
- (e) **DATA ENTRY ENTER** Factory Defaults recall

NOTE

Assure highlighted area indicates **YES** before proceeding.

- (f) **DATA ENTRY ENTER** Factory Defaults restored

(2) Set signal generator for a 121.1 MHz, 0 dB output and turn **RF OUTPUT** off. Connect signal generator **RF OUTPUT** to power splitter input.

(3) Connect one power splitter output to **TI ANTENNA** and the other splitter output to measuring receiver sensor module.

(4) Set measuring receiver to measure AM with **PEAK±/2** detector selected.

NOTE

Pressing **More (F6)** will scroll various options on the bottom of the display. The options will change the functions assigned to the **F1** through **F6** function keys. This may be necessary to obtain the **Freq (F1)** and **Atten (F4)** options required in the following tests.

(5) Press **MODE RCVR** (Receiver Display), **Freq (F1)** (Frequency), **DATA ENTRY 1 2 1 . 1** and **M** keys (121.1 MHz).

(6) Press **Atten (F4)** (Attenuation), **DATA SCROLL** arrow keys to select **40 dB**, and press **DATA ENTRY ENTER** (40 dB) key.

(7) Press **SETUP** (MODE RCVR Menu), **DATA ENTRY 2** (Select Mod), **DATA SCROLL** arrow keys to select **11. User Defined**, and **DATA ENTRY ENTER** key (to select User Defined Mod).

- (8) Press **DATA ENTRY 1** (Modulation), and **2** (AM) keys.
- (9) Press **DATA ENTRY 2** (IF Filters), **DATA SCROLL** arrow keys to select **3. 300 kHz** (IF Filter), and **DATA ENTRY ENTER** key (to select 300 kHz IF Filter).
- (10) Press **DATA ENTRY 3** (Post Detection), **2** (to select Post Detected Low Pass Filter), **3 K** (3 kHz LP) and **ESC (F6)** (Escape) keys.
- (11) Press **DATA ENTRY 5** (Select AGC Type), **1** (User Defined), and **1** (Measurement) keys.
- (12) Press **Ret (F5)** (Return) key.
- (13) Adjust signal generator controls for 30 percent AM, and a modulation rate of 1 kHz and set **RF OUTPUT** on and **AM** off. Record **TI MOD %** indication.

NOTE

Set measuring receiver filters as needed.

(14) Set signal generator **AM** on and adjust controls for a 30% AM indication on measuring receiver. Algebraically subtract **TI MOD %** indication from indication recorded in (13) above. If difference is not within limits specified in table 21, perform **b** below.

(15) Set signal generator **AM** off and repeat technique of (7) through (14) above for remaining signal generator and **TI** settings in table 21.

Table 21. Amplitude Modulation Accuracy

Signal generator Mod rate	Measuring ¹ receiver indications	Test instrument indications			
		LP filter	MOD range	Min (%)	Max (%)
1 kHz	30%	3 kHz	Autorange	-3	+3
1 kHz	40%	3 kHz	Autorange	-3	+3
1 kHz	50%	3 kHz	Autorange	-6	+6
1 kHz	60%	3 kHz	Autorange	-6	+6
1 kHz	70%	3 kHz	Autorange	-6	+6
1 kHz	80%	3 kHz	Autorange	-6	+6
1 kHz	90%	3 kHz	Autorange	-6	+6
100 Hz	30%	3 kHz	40%	-3	+3
100 Hz	90%	3 kHz	100%	-6	+6
10 kHz	90%	15 kHz	100%	-6	+6
10 kHz	30%	15 kHz	40%	-3	+3

¹Set the measuring receiver filters as needed.

b. Adjustments

NOTE

Pressing **More (F6)** will scroll various options on the bottom of the display. The options will change the functions assigned to the **F1** through **F6** function keys. This may be necessary to obtain the **Freq (F1)** and **Atten (F4)** options required in the following tests.

(1) Press **Mod (F2)** (Modulation Mode), **DATA SCROLL** arrow keys to select **AM2**, and **DATA ENTRY ENTER** key (to select AM2).

(2) Press the **FIELD SELECT** arrow keys to highlight **MOD** (Meter) function, and press **DATA ENTRY ENTER** key (Modulation Meter).

(3) Press **Range (F1)** (Modulation Range) and press **DATA SCROLL** arrow keys to select **100%** (MOD range), press **DATA ENTRY ENTER** key (to select 100% AM range), and press **Ret (F6)** (Return).

(4) Position signal generator controls for 80% AM, and a modulation rate of 1000 Hz. Adjust signal generator amplitude modulation until measuring receiver indicates 80% AM.

(5) Press **MODE MTRS** (Meters Menu), **AUX (F6)** (Auxiliary Functions Menu), and **DATA ENTRY 1** (Calibrations) keys. Press **FIELD SELECT** arrow keys to highlight **4. Modulation Meter** and press **DATA ENTRY ENTER** key (to select modulation meter calibration).

(7) Press **DATA ENTRY ENTER** key (to activate correction factor mode). Press **DATA ENTRY** keys to enter value displayed on measuring receiver into TI data field, and press **DATA ENTRY ENTER** key (to set new correction factor).

(8) Press **Ret (F5)** (Return), **MODE RCVR** (Receiver Display), **SHIFT**, and **Y** (Backup Cal Data ? y/n) keys and repeat paragraph **23 a** above.

24. Frequency Error Meter and RF Counter

a. Performance Check

(1) Press the key sequence listed in (a) through (f) below:

- (a) **MODE MTRS** Meters Menu
- (b) **AUX (F6)** Auxiliary
- (c) **MEMORY RCL** Recall
- (d) **FIELD SELECT ↑** Highlight **10. Factory Defaults**
- (e) **DATA ENTRY ENTER** Factory Defaults recall

NOTE

Assure highlighted area indicates **YES** before proceeding.

- (f) **DATA ENTRY ENTER** Factory Defaults restored

(2) Press **MODE RCVR** (Receiver Display), **Freq (F1)** (Frequency), **DATA ENTRY 1**, and **M** (1 MHz), and **(F3) T/R** keys.

(3) Connect frequency counter **10 MHZ OUT** to synthesizer/level generator **40/N MHZ REF INPUT**.

(4) Connect synthesizer/level generator **OUTPUT** to TI **T/R** and frequency counter **A** input.

(5) Press **MODE MTRS** key (Meters Menu) and **DATA ENTRY 2** key (Freq Error Meter/Freq Meter).

(6) Set synthesizer/level generator for a 1 MHz, 0 dBm output.

(7) Adjust synthesizer/level generator frequency until TI **FREQ (MHz)** display indicates **1.000000 MHz**.

(8) Frequency counter will indicate 1 MHz ± 0.5 Hz. TI **FREQ ERR** display will indicate within ± 0.5 Hz.

(9) Adjust synthesizer/level generator frequency until TI **FREQ (MHz)** display indicates **1.000020 MHz**.

(10) Frequency counter will indicate 1.000020 MHz ± 0.5 Hz. TI **FREQ ERR** display will indicate between +19.5 and +20.5 Hz.

(11) Adjust synthesizer/level generator frequency until TI **FREQ (MHz)** display indicates **0.999980 MHz**.

(12) Frequency counter will indicate .999980 MHz ± 0.5 Hz. TI **FREQ ERR** display will indicate between -19.5 and -20.5 Hz.

(13) Disconnect synthesizer/level generator from frequency counter and TI.

(14) Connect frequency counter **10 MHz OUT** to signal generator **EXT REF INPUT**.

(15) Connect signal generator **RF OUTPUT** to frequency counter **C** input and to TI **T/R**.

(16) Press key sequence listed in (a) through (n) below:

- (a) **MODE RCVR** Receiver Display
- (b) **SETUP** Setup Screen
- (c) **DATA ENTRY 1** Set Rcvr Freq
- (d) **DATA ENTRY 9 0 0** 900
- (e) **DATA ENTRY ENTER** 900 MHz
- (f) **DATA ENTRY 2** Select Mode
- (g) **FIELD SELECT** arrow keys .. Highlight **11. User Defined**
- (h) **DATA ENTRY ENTER** Select **11. User Defined**
- (i) **DATA ENTRY 2** IF Filters
- (j) **DATA ENTRY 3** 300 kHz
- (k) **F6 (Esc)** Rcvr Menu
- (l) **F5 (Ret)** Receiver Display

- (m) **MODE MTRS** Meter Menu
- (n) **DATA ENTRY 2** Freq Error Meter/Freq Meter

(17) Set signal generator for a 900.15 MHz, 0 dBm output.

(18) Adjust signal generator frequency until TI **FREQ (MHz)** display indicates **900.15000 MHz**.

(19) Frequency counter will indicate 900.15000 MHz \pm 450.08 Hz. TI **FREQ ERR** display will indicate 150 kHz.

(20) Adjust signal generator frequency until TI **FREQ (MHz)** display indicates **899.85000 MHz**.

(21) Frequency counter will indicate 899.85000 MHz \pm 449.93 Hz. TI **FREQ ERR** display will indicate 150.0 kHz.

b. Adjustments. No further adjustments can be made.

25. AF Counter

a. Performance Check

(1) Press key sequence listed in (a) through (f) below:

- (a) **MODE MTRS** Meters Menu
- (b) **AUX (F6)** Auxiliary
- (c) **MEMORY RCL** Recall
- (d) **FIELD SELECT** \uparrow Highlight **10. Factory Defaults**
- (e) **DATA ENTRY ENTER** Factory Defaults recall

NOTE

Assure highlighted area indicates **YES** before proceeding.

- (f) **DATA ENTRY ENTER** Factory Defaults restored

(2) Press **MODE RCVR** (Receiver Display), **Freq (F1)** (Frequency), **DATA ENTRY 1** and **M** (1 MHz) keys.

(3) Connect frequency counter **10 MHz OUT** to function/arbitrary generator **10 MHz In**.

(4) Connect function/arbitrary generator **Output** to TI **EXT MOD IN** and frequency counter **A** input.

(5) Press key sequence listed in (a) through (e) below:

- (a) **FIELD SELECT** arrow key Highlight **AF**
- (b) **DATA ENTRY ENTER** AUDIO FREQUENCY DISPLAY
- (c) **F4** Input

(d) **DATA SCROLL** arrow keys ... Highlight **EXT MOD**

(e) **DATA ENTRY ENTER** Select **EXT MOD**

(6) Press **Range (F1)** (Audio Frequency Range) and **DATA SCROLL** arrow keys to select **2 kHz** range. Press **DATA ENTRY ENTER** key (2 kHz Audio Frequency Range).

(7) Set function/arbitrary generator amplitude for 1 V p-p and adjust frequency until **TI AUDIO FREQUENCY** display indicates 1.000 kHz.

(8) Frequency counter will indicate between 998.995 and 1001.005 Hz.

(9) Press **DATA SCROLL** arrow keys to select **20 kHz** range and press **DATA ENTRY ENTER** key (20 kHz Audio Frequency Range).

(10) Adjust function/arbitrary generator frequency until **TI AUDIO FREQUENCY** display indicates 10.000 kHz.

(11) Frequency counter will indicate between 9.998995 and 10.001005 kHz.

(12) Press **DATA SCROLL** arrow keys to select **200 kHz** range and press **DATA ENTRY ENTER** key (200 kHz Audio Frequency Range).

(13) Adjust function/arbitrary generator frequency until **TI AUDIO FREQUENCY** display indicates 40.00 kHz.

(14) Frequency counter will indicate between 39.98998 and 40.01002 kHz.

b. Adjustments. No further adjustments can be made.

26. Power Supply

a. Performance Check

(1) Press **TI POWER** key off and remove top and bottom covers.

(2) Press **TI POWER** key **ON** and allow 5 minutes for warm-up.

(3) Connect multimeter **INPUT HI** to orange wire on power termination and **LO** to chassis ground.

(4) If multimeter does not indicate between +5.0 and +5.1 V dc, perform **b** (1) below.

(5) Connect multimeter **INPUT HI** to red wire and **LO** to ground lug (black wire on the power term assembly (fig. 1).

(6) If multimeter does not indicate between +15.0 and +15.1 V dc perform **b** (2) below.

(7) Connect multimeter **INPUT HI** to yellow wire.

(8) Multimeter will indicate between -15.0 and -15.1 V dc.

(9) Connect multimeter **INPUT HI** to blue wire (fig. 5).

(10) Multimeter will indicate between +11.8 and +12.1 V dc.

(11) Connect multimeter **INPUT HI** to FL 16 (fig. 5) on 1st LO assembly.

(12) Multimeter will indicate between +33.0 and +35.0 V dc.

(13) Connect multimeter **INPUT HI** to A26TP2 (fig.1) and **LO** to A26TP3 (fig.1).

(14) If multimeter does not indicate $+4.0960 \pm 0.0001$ V dc, perform **b(3)** below.

(15) Disconnect multimeter from TI, press **POWER** key off, and reinstall top and bottom covers. Press TI **POWER** key **ON**.

b. Adjustments

(1) Adjust A16R37 (fig. 1) for a multimeter indication of +5 V dc (R).

(2) Adjust A16R25 (fig. 1) for a multimeter indication of +15 V dc (R).

(3) Adjust A26R18 (fig. 1) for a multimeter indication of $+4.0960 \pm 0.0001$ V dc (R).

27. J-4843A/GRM and PL-1536/GRM Self Test (AN/GRM-122 only)

NOTE

The following test is performed for the AN/GRM-122. Perform paragraph 28 . J-4843/GRM Self Test (AN/GRM-114B only) for the AN/GRM114B. For calibration of the TS-4317/GRM proceed to paragraph 29 Final Procedure.

a. Performance Check

(1) Press key sequence listed in (a) through (o) below:

- (a) **MODE MTRS** Meters Menu
- (b) **AUX (F6)** Auxiliary
- (c) **MEMORY RCL** Recall
- (d) **FIELD SELECT ↑** Highlight **10. Factory Defaults**
- (e) **DATA ENTRY ENTER**..... Factory Defaults recall

NOTE

Assure highlighted area indicates **YES** before proceeding.

- (f) **DATA ENTRY ENTER** Factory Defaults restored
- (g) **MODE RCVR** Receiver Menu
- (h) **Sp Tst (F5)** SINGARS Verification Test Menu
- (i) **More “x” (F6)** Until **BIT 1 (F2)** and **BIT 2 (F3)** are displayed
- (j) **BIT 1 (F2)**..... BIT Level 1 Test
- (k) **AUTO** OPER Mode (Auto Mode)
- (l) **GO**..... BIT Level 1 Test begins

NOTE

Random numbers may be displayed as test is running. The testing process can be halted by pressing the **STOP** key anytime during the testing process. If a test fails, the Diagnostic Menu appears. The operator can view the Test Results of the failed test (**Disp (F3)**), perform a Debug Operation on the failed test (**Debug (F2)**), retest failed test (**Cont (F1)**) or retest from the beginning of the testing process (**Restart (F6)**).

- (m) **Rtn (F6)** Return to SINCGARS Verification Test Menu

NOTE

Attach Test Fixture TF-119A to the UUT Connector on the PL-1536/GRM.

- (n) **BIT 2 (F3)** BIT Level 2 Test
- (o) **GO**..... BIT Level 2 Test begins

NOTE

If a test fails, the Diagnostic Menu appears. The operator can view the Test Results of the failed test (**Disp (F3)**), perform a Debug Operation on the failed test (**Debug (F2)**), retest failed test (**Cont (F1)**) or retest from the beginning of the testing process (**Restart (F6)**).

- (2) Remove Test Fixture TF-119A and proceed to paragraph 29 Final Procedure.

b. Adjustments. No adjustments can be made. For test failures refer to TM 11-6625-3246-40.

28. J-4843/GRM Self Test (AN/GRM-114B only)

a. Performance Check

- (1) Press key sequence listed in (a) through (m) below:

- (a) **MODE MTRS** Meters Menu
- (b) **AUX (F6)** Auxiliary
- (c) **MEMORY RCL**..... Recall
- (d) **FIELD SELECT ↑** Highlight **10. Factory Defaults**
- (e) **DATA ENTRY ENTER**..... Factory Defaults recall

NOTE

Assure highlighted area indicates **YES** before proceeding.

- (f) **DATA ENTRY ENTER** Factory Defaults restored
- (g) **MODE RCVR** Receiver Mode
- (h) **More (F6)**..... Until **Sp Tst (F5)** appears
- (i) **Sp Tst (F5)**.....
- (j) **OPER (F1)**.....
- (k) **More (F6)**..... Until **7238 (F1)** appears
- (l) **7238 (F1)**
- (j) **DATA ENTRY ENTER** Press this key 5 more times

(2) Connect signal generator **RF OUTPUT** to J-4843/GRM **DUPLEX IN**. Connect 30dB (10W) attenuator to J-4843/GRM **RF AMP OUT** then connect attenuator to spectrum analyzer **INPUT 50Ω**.

(3) Set signal generator for a 35 MHz at 0 dBm output. Press **Debug (F2)**, **(F6)**, and **Key (F1)**.

- (4) Spectrum analyzer should indicate 6 dBm (±1 dBm) at 35MHz. Record level.
- (5) Set Spectrum analyzer to 70 MHz.
- (6) Verify 2^d Harmonic at <-20 dBc from level recorded in (4) above.
- (7) Press **Unkey (F2)** and **Exit (F5)**.
- (8) Disconnect external test equipment.
- (9) Press key sequence listed in (a) through (k) below:

- (a) **MODE MTRS** Meters Menu
- (b) **AUX (F6)** Auxiliary
- (c) **MEMORY RCL** Recall
- (d) **FIELD SELECT ↑** Highlight **10. Factory Defaults**
- (e) **DATA ENTRY ENTER**..... Factory Defaults recall
- (f) **MODE MTRS**..... Meters Menu
- (g) **AUX (F6)** Auxiliary
- (h) **FIELD SELECT ↑** Highlight **5. External I/O**
- (i) **DATA ENTRY ENTER** Select External I/O

- (j) **FIELD SELECT** ↑ Highlight **1. RS-232**
- (k) **DATA ENTRY ENTER** Select RS-232

NOTE

Adjust settings so TI reflects the following:

Operation Mode	Host
Baud Rate	19200
Data Bits	8
Stop Bits	1
Parity	None
Handshake	Xon/Xoff
Echo	Off

(10) Press **ESC (F6)** twice then **TERM (F5)**.

(11) Connect Serial Interface (null modem) Cable Assembly between Test Set RS-232 connector and Test Adapter RS-232 Connector. Connect Test Fixture TF-119 to Test Adapter.

(12) Press **SHIFT, T, E, S, T, C, O, N, N, SHIFT and ENTER** Keys.

(13) Press **1** on DATA ENTRY Keypad.

NOTE

Test is performed automatically with user instructions given as needed.

b. Adjustments. No adjustments can be made. For test failures refer to TM 11-6625-3245-40.

29. Final Procedure

- a.** Deenergize and disconnect all equipment.
- b.** Annotate and affix DA label/form in accordance with TB 750-25.

By Order of the Secretary of the

Official



JOYCE E. MORROW
*Administrative Assistant to the
Secretary of the Army*

0611402

PETER J. SCHOOMAKER
*General, United States Army
Chief of Staff*

Distribution:

To be distributed in accordance with the initial distribution number (IDN) 344492,
requirements for calibration procedure TB 9-6625-2296-35.

Instructions for Submitting an Electronic 2028

The following format must be used if submitting an electronic 2028. The subject line must be exactly the same and all fields must be included; however, only the following fields are mandatory: 1, 3, 4, 5, 6, 7, 8, 9, 10, 13, 15, 16, 17, and 27.

From: "Whomever" whomever@redstone.army.mil
To: <2028@redstone.army.mil

Subject: DA Form 2028

1. **From:** Joe Smith
2. **Unit:** home
3. **Address:** 4300 Park
4. **City:** Hometown
5. **St:** MO
6. **Zip:** 77777
7. **Date Sent:** 19-OCT -93
8. **Pub no:** 55-2840-229-23
9. **Pub Title:** TM
10. **Publication Date:** 04-JUL-85
11. **Change Number:** 7
12. **Submitter Rank:** MSG
13. **Submitter FName:** Joe
14. **Submitter MName:** T
15. **Submitter LName:** Smith
16. **Submitter Phone:** 123-123-1234
17. **Problem:** 1
18. **Page:** 2
19. **Paragraph:** 3
20. **Line:** 4
21. **NSN:** 5
22. **Reference:** 6
23. **Figure:** 7
24. **Table:** 8
25. **Item:** 9
26. **Total:** 123
27. **Text**

This is the text for the problem below line 27.

